

# ADVANCED HIGH CEILING Rev 6 - Emergency Pack

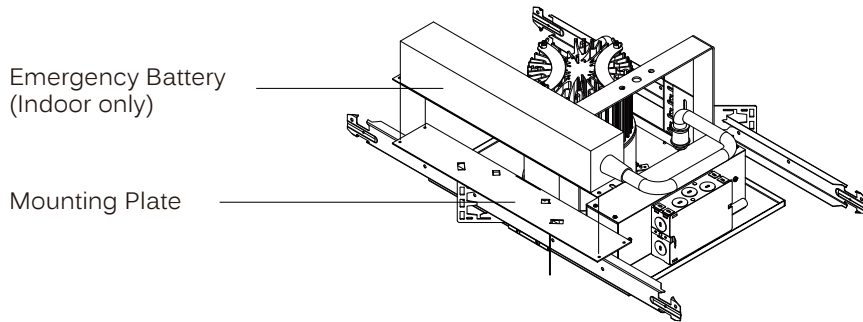

## Emergency Pack



## Wiring Diagram

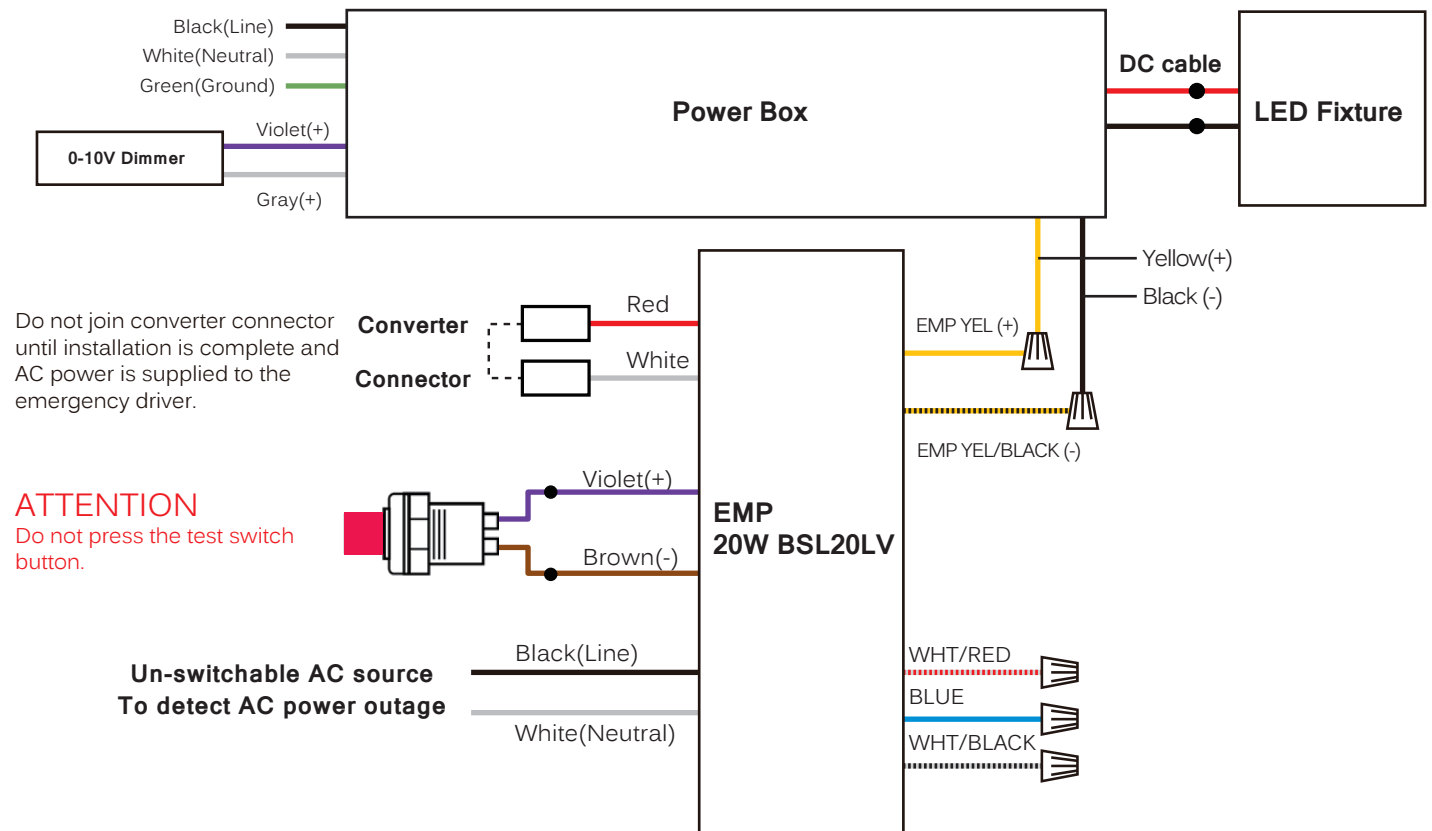

## Test method

Disconnect the AC power of the LED fixture and EMP. The LED Fixture should be lit by EMP.

# BSL20LV

## Installation Instructions

CLASS 2 OUTPUT

EMERGENCY LED DRIVER

# bodine



### **! IMPORTANT SAFEGUARDS !**

**WHEN USING ELECTRICAL EQUIPMENT, BASIC SAFETY PRECAUTIONS SHOULD ALWAYS BE FOLLOWED, INCLUDING THE FOLLOWING:**

## **READ AND FOLLOW ALL SAFETY INSTRUCTIONS**

1. Do not join converter connector until installation is complete and AC power is supplied to the emergency driver.
2. This product is for use with an emergency LED lighting load and supplies 20.0 W of power with a maximum rated current of 1.1 A and a maximum voltage of 50 VDC in emergency mode for a minimum of 90 minutes.
3. Make sure all connections are in accordance with the National Electrical Code or Canadian Electrical Code and any local regulations.
4. To reduce the risk of electric shock, disconnect both normal and emergency power supplies and converter connector of the emergency driver before servicing.
5. This emergency driver is suitable for both factory or field installation. For field installation, please see the instructions on page 2.
6. This product is suitable for use in damp locations where the ambient temperature is 0°C minimum, +50°C maximum. Product is not suitable for heated air outlets and wet or hazardous locations. Maximum allowable case temp is 65°C. See Product Unit Label for measurement location.
7. An unswitched AC power source is required (120-277 VAC, 50/60 Hz).
8. Do not install near gas or electric heaters.
9. Do not attempt to service the battery. A sealed, no-maintenance battery is used that is not field replaceable. Contact the manufacturer for information on service.
10. The use of accessory equipment not recommended by the manufacturer may cause an unsafe condition.
11. Do not use this product for other than intended use.
12. Servicing should be performed by qualified service personnel.
13. Equipment should be mounted in locations and at heights where it will not be subjected to tampering by unauthorized personnel.
14. For Canadian application the output terminals should be in compliance with the accessibility requirement of the Canadian Electric Code.
15. This device complies with part 15 of the FCC Rules. Operation is subject to the following two conditions: (1) this device may not cause harmful interference, and (2) this device must accept any interference that may cause undesired operation.
16. This product's chassis must be grounded.

## **SAVE THESE INSTRUCTIONS**



Ni - Cd

**THIS PRODUCT CONTAINS A RECHARGEABLE NICKEL-CADMIUM BATTERY.  
THE BATTERY MUST BE RECYCLED OR DISPOSED OF PROPERLY.**

# ADVANCED HIGH CEILING Emergency Pack



## Specifications

### UL Listed for US and Canada

Listed to UL924 and tested to CSA 22.2 No. 141  
For Field or Factory Installation (Indoor and Damp)

### Illumination Time

90 Minutes

### Full Warranty

5 Years (NOT pro-rata)

### Universal Input Voltage

120-277 VAC, 50/60 Hz

### AC Input Current

95 mA Maximum

### AC Input Power Rating

8.5 W Maximum

### Output Current and Voltage

BSL20LV 1A-0.40A 20V-50V (Class 2)  
BSL20MV 0.40A-0.15A 50V-130V  
BSL20HV 0.16A-0.10A 125V-200V

### Output Power

20.0 W

### Test Switch/Charging Indicator Light

Illuminated Test Switch 2W-ITS  
(2W-ITS can be mounted up to 50 feet from fixture)

### Battery

High-Temperature, Maintenance-Free  
Nickel-Cadmium Battery  
7- to 10-Year Life Expectancy

### Battery Charging Current

275 mA

### Recharge Time

24 Hours

### Temperature Rating (Ambient)

0°C to +50°C (32°F to 122°F)

### Dimensions

16.6" x 2.8" x 2.85" (422 mm x 71 mm x 73 mm)  
2' (610 mm) Flexible Conduit  
Mounting Center 16.05" (408mm)

### Weight

7.1 lbs. (3.22 kg)

## Benefits:

- Smart Charger Technology for low energy consumption.
- Meets CEC Title 20 (California Energy Commission) efficiency standards.
- Listed for field or factory installation - UL 924 and CSA C22.2 No. 141 Emergency Lighting Compliant.
- Class 2 output - UL 1310 Certified, CSA 22.2 No 223-M91 compliant (BSL20LV only).
- Emergency mode nominal lumen output of up to 2,600 lumens.
- Universal input (120-277 VAC).
- 2 wire input to help reduce wiring errors.
- Auto-sensing output within each range.
- RoHS Compliant.

## Dimensions:

16.6" x 2.8" x 2.85" (mounting center - 16.05")

