

RIO 6

SPECIFICATION SHEET
STATIC WHITE

BI-DIRECTIONAL CYLINDER

Housing

Diameter : Ø6.38" | Height : 11.8" | Weight : 8.4 lbs (Small), 11.5" (Large)

Material

Housing : Extruded Aluminum
Optics : Aluminum Reflector

Power Input

Downlight : 25W, 45W, 70W | 120V, 120-277V
Uplight : 25W, 45W | 120V, 120-277V

Lumen Output

Downlight : 3,265 lm (25W), 5,875 lm (45W), 9,135 lm (70W)
Uplight : 3,305 lm (25W), 5,955 lm (45W)

Dimming

Superior 0-10V : Dims to off
TRC : Linear line-voltage phase control, dims to 1%
DALI : Dims to 1%

Color Quality

CRI 85, CRI 93 | UGR ≤ 19

Rated Life

> 100,000 Hours (L70)

Finish

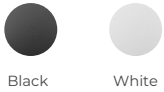

Color Temperature



Optics

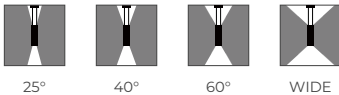

Mounting

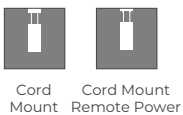

Warranty

5 Year limited warranty

Listing



Power and Balance

The Rio Series is a clean, architectural bi-directional cylinder offered in 4" and 6" apertures, designed for spaces where form and performance carry equal weight. Selectable wattage options allow designers to balance uplight and downlight or bias the output downward, with separate dimming control for each channel to fine-tune comfort and visual hierarchy.

With efficacies exceeding 140 lm/W, Rio delivers high output with minimal energy demand. An integrated suspension and power cable keeps the profile uncluttered and installation straightforward. An outdoor-rated option is available for cohesive indoor-to-outdoor design continuity.



SPECIFICATION SHEET / STATIC WHITE

RIO 6 BI-DIRECTIONAL CYLINDER



SPECIFICATION

PROJECT NAME

DATE

CATALOG #

QUANTITY

The product configurator function on this page works only with the latest version of Chrome or Adobe Acrobat Reader.

<input type="text" value="RIO6"/>	MODEL	RIO 6		
<input type="text"/>	WATTAGE	50 Downlight: 25W Uplight: 25W 95 Downlight: 70W Uplight: 25W	70 Downlight: 45W Uplight: 25W	90 Downlight: 45W Uplight: 45W
<input type="text"/>	CCT / CRI	278 2700K / CRI 85 309 3000K / CRI 93 408 4000K / CRI 85	279 2700K / CRI 93 358 3500K / CRI 85	308 3000K / CRI 85 359 3500K / CRI 93
<input type="text"/>	VOLTAGE	120 120V	UNV 120 – 277V	
<input type="text"/>	DIMMING	NOD Non-Dimming TRC² Linear line-voltage phase control, dims to 1% Single (Up/Down Together)	SPVS¹ Superior 0-10V dims to off Single (Up/Down Together) DALID³ DALI dims to 1% Dual (Up/Down Separately)	SPVD¹ Superior 0-10V dims to off Dual (Up/Down Separately)
<input type="text"/>	BEAM ANGLE	Downlight		
<input type="text"/>		25 25° WD⁴ Wide	40 40°	60 60°
<input type="text"/>	BEAM ANGLE	Uplight		
<input type="text"/>		25 25° WD⁴ Wide	40 40°	60 60°
<input type="text"/>	FINISH	BLK Black	WHT White	
<input type="text"/>	MOUNTING	CM#(2/4/6/8/10)⁵ Thin Cord Mount (2, 4, 6, 8, 10 ft.)	CM#RM(2/4/6/8/10)^{5,6} Thin Cord Mount with Remote Power (2, 4, 6, 8, 10 ft.)	
<input type="text"/>	ACCESSORIES	EMP Remote Emergency Pack	HC⁷ Hex Cell Louver	

CLEAR FORM

¹ SPV with 95W does not support dimming to off
² TRC is only compatible with 120V and is not compatible with 95W
³ DALI with 95W can only dim to 10%
⁴ WD option reduces delivered lumens by ~20%
⁵ Replace “#” with the required length designation. ex: CM2, CM4
⁶ CM#RM is not compatible with 50W, 70W, 90W
⁷ HC reduces delivered lumens by ~30% and is not compatible with WD

TECHNICAL DETAILS

Electrical

- Downlight : 3,265 lm (25W), 5,875 lm (45W), 9,135 lm (70W)
- Uplight : 3,305 lm (25W), 5,955 lm (45W)
- Power Input : 120V, Universal (120-277V)
- Operating Temperature : -13°F~104°F
- Surge Protection : Built-in is 2.5KV
- Power Factor Greater than 0.9
- Remote Emergency Pack : Bodine BSL20B2UEK55C111

LED Features

- Color Temperature : 2700K, 3000K, 3500K, 4000K
- CRI 85, CRI 93
- UGR ≤ 19
- Long lasting LED luminaire tested under TM21 lumen maintenance L70 @ 100,000 Hrs

Optics

- Aluminum Reflector
- Beam Angle : 25°, 40°, 60°, WD

Advanced Dimming

- Proprietary VX Driver™ is incorporated to all dimming options for video flicker-free lighting
- Superior 0-10V : Dims to off
 - Single Dimming (Controls Up/Down Together)
 - Dual Dimming (Controls Up/Down Separately)
- TRC : Linear line-voltage phase control, dims to 1%
 - Single Dimming (Controls Up/Down Together)
- DALI : Dims to 1%
 - Dual Dimming (Controls Up/Down Separately)

Housing

- Diameter : Ø6.38"
- Height : 11.8"
- Canopy : 6.5" x 2" (Small), 7.3" x 3.55" (Large)
- Material : Extruded Aluminum
- Weight : 8.4 lbs (Small), 11.5" (Large)

Mounting

- Thin Cord Mount 2ft, 4ft, 6ft, 8ft, 10ft
- Thin Cord Mount 2ft, 4ft, 6ft, 8ft, 10ft with Remote Power

Warranty

- 5-year limited warranty

Listing

- ETL Damp Location Listed
- CE
- FCC

PERFORMANCE SUMMARY*

Delivered Lumens						
TOTAL WATTAGE	Uplight Wattage	Downlight Wattage	2700K	3000K	3500K	4000K
50W	25W	25W	3,030 / 2,990lm	3,215 / 3,170lm	3,290 / 3,245lm	3,305 / 3,265lm
70W	25W	45W	3,030 / 5,380lm	3,215 / 5,710lm	3,290 / 5,840lm	3,305 / 5,875lm
90W	45W	45W	5,455 / 5,380lm	5,785 / 5,710lm	5,920 / 5,840lm	5,955 / 5,875lm
95W	25W	70W	3,030 / 8,365lm	3,215 / 8,880lm	3,290 / 9,085lm	3,305 / 9,135lm

*Tolerance ±8%

* For specifications requiring a CRI of 93, apply a 0.75 multiplier to the lumen output values listed.

Current Consumption		
WATTAGE / VOLT	120V	277V
50W	0.46A	0.20A
70W	0.64A	0.28A
90W	0.83A	0.36A
95W	0.87A	0.38A

PHOTOMETRICS

Below is a typical photometric representation of theRio 6 fixture. Please download IES files to ensure exact photometric value.

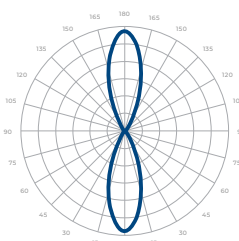

25°

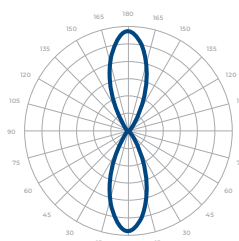

40°

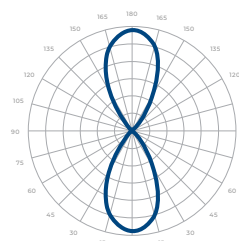

60°

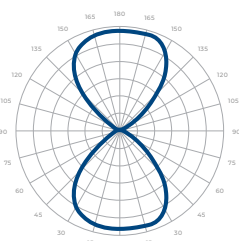

WIDE

DIMENSIONS

50W/70W/90W

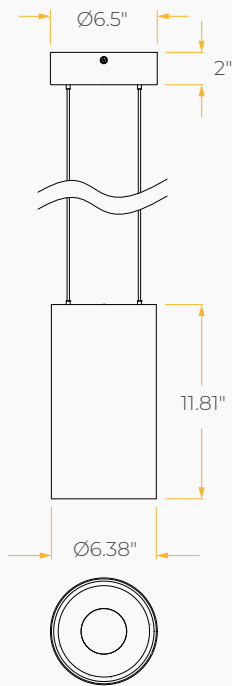

95W

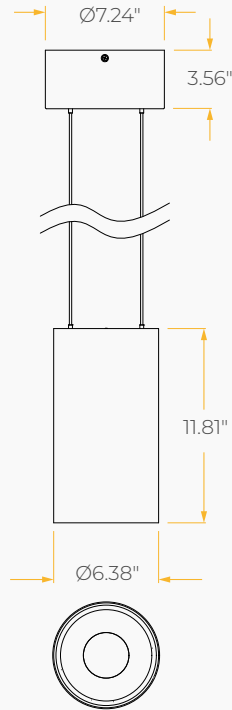

Mounting Plate

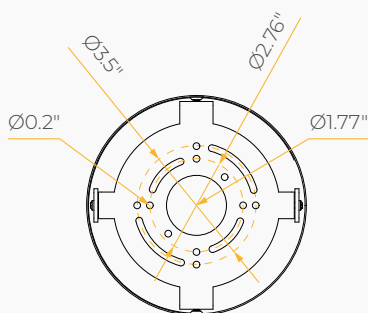

95W Remote Power Box

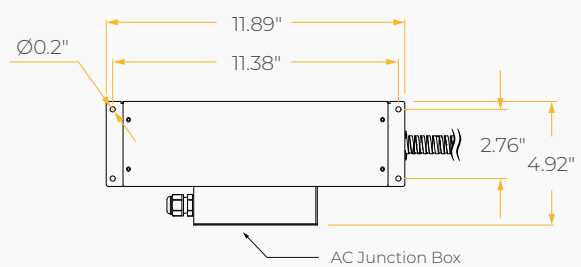

MOUNTING OPTIONS*

*Junction box not included

