

# REV 4

## QUIET CEILING DESIGN HIGH LUMEN RECESSED DOWNLIGHT

### Housing

Aperture : Ø4.3" | Oversize Trim : 5.3" | Ceiling Cutout : 5"  
Maximum Ceiling Thickness : 2" | Height : 8" | Weight : 8.8 lbs

### Material

Housing : Extruded Aluminum  
Reflector : Flow Forming Aluminum

### Power Input

20W, 40W | 120V, 277V

### Lumen Output

1,600 lm (20W), 3,050 lm (40W)

### Dimming

Superior 0-10V : Dims to 1%  
DMX : High resolution dims to 0.1%  
DALI : Dims to 10%

### Color Quality

CRI 85

### Rated Life

> 60,000 Hours (L70)

### Finish



Black



White

### Color Temperature



ColorFlip™ Warm Dim  
1900K ↔ 3000K

### Optics



45°



55°

### Warranty

5 Year limited warranty

### Listing



## SPECIFICATION SHEET NEW CONSTRUCTION - WARM DIM

## Precision Engineered For High Performance.

4-inch aperture high lumen recessed downlight utilizing Meteor Lighting's proprietary ColorFlip™ Warm Dim solution, that results in superior efficacy and heat management.

This product is compatible with all existing 0-10V and DMX control systems. Bringing ambient lighting to your spaces.

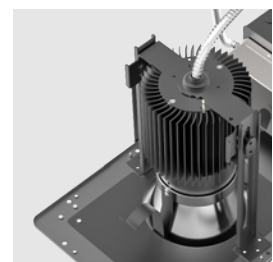
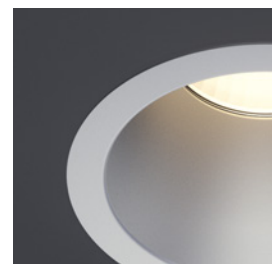

**SPECIFICATION**

PROJECT NAME

DATE

CATALOG #

QUANTITY

<b>RS4N</b>	MODEL	<b>REV 4 WITH NEW CONSTRUCTION FRAME</b>		
	WATTAGE	<b>20</b> 20W	<b>40</b> 40W	<b>60</b> 60W
<b>WDIM</b>	CCT / CRI	<b>WDIM</b> 1900K - 3000K		
	VOLTAGE	<b>120</b> 120V	<b>277</b> 277V	
	DIMMING	<b>SPV</b> Superior 0-10V dims to 1% <b>DALI</b> DALI dims to 10%	<b>DMX</b> DMX dims to 0.1% (XLR Sockets)	<b>DMX(RJ45)</b> DMX dims to 0.1% (RJ45 Sockets)
	BEAM ANGLE	<b>45</b> 45° with Standard Trim	<b>55</b> 55° with Low Trim	
	FINISH*	<b>BLK</b> Black	<b>WHT</b> White	
	ACCESSORIES	<b>SCA410</b> Sloped Ceiling Adapter 8°-12°	<b>BUB</b> Butterfly Bracket	

\* Finish indicates Trim only, with standard matte silver reflector.

**TECHNICAL DETAILS**

**Electrical**

- 1,600lm (20W)
- 3,050 lm (40W)
- Power Input: 120V or 277V
- Operating Temperature: -20°F~104°F
- Surge Protection: Built-in is 4KV
- Power Factor Greater than 0.9

**LED Features**

- Warm Dim™ Tunable White 1900K ↔ 3000K
- CRI 85
- Long lasting LED luminaire tested under TM21 lumen maintenance L70 @ 60,000 Hrs

**Optics**

- Flow Forming Aluminum Reflector
- Beam Angle : 45°, 55° (Low Trim only)

**Advanced Dimming**

- Proprietary VX Driver™ is incorporated to all dimming options for video flicker-free lighting
- Superior 0-10V : Dims to 1%
- DMX : High resolution dims to 0.1% (Supports ANSI E1.20 RDM protocol)
- DALI : Dims to 10%

**New Construction Housing**

- Aperture : Ø4.25"
- Height : 8"
- Weight : 8.8 lbs
- Material : High Pressure Aluminum
- Non-IC Rated, insulation must be kept >1ft from housing
- Oversize Trim : 5.3"
- Ceiling Cutout : 5"
- Maximum Ceiling Thickness : 2"
- Tool-less top access allows service from above and below
- Light engine, optics, and driver(s) accessible from below ceiling

\*Note: C-Channel / Mounting Channels / T-Bar Hangers are purchased from a third party

**Warranty**

- 5-year limited warranty

**Listing**

- ETL Damp Location Listed
- FCC

**PERFORMANCE SUMMARY\***

Warm Dim	1900K					3000K
<b>DMX</b> CCT Signal (%)	7%	20%	40%	60%	80%	100%
<b>0-10V</b> CCT Voltage	0.7	2	4	6	8	10
<b>20W</b>	30lm	145lm	430lm	815lm	1,230lm	1,600lm
<b>40W</b>	60lm	275lm	825lm	1,555lm	2,350lm	3,050lm

\*Beam Angle: 35° \*Tolerance ±8%

**PHOTOMETRICS**

Below is a typical photometric representation of the Rev 4 fixture. Please download IES files to ensure exact photometric value.

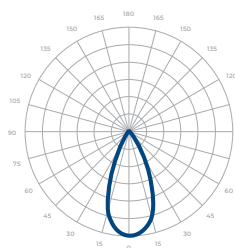

45°

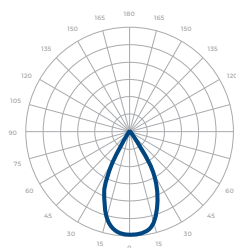

55°

## DMX REQUIREMENTS

The Rev 4 LED Warm Dim fixture with DMX is a **single channel dmx** unit.

When placing an order, please indicate DMX address. (The DMX address will be listed on the back of the fixture.)

The LED fixture provides RJ45 socket or XLR socket to connect. (DMX cable **not** included.)

The final fixture should be terminated by the use of a DMX terminator (by others).

CONNECTION	RJ45 (CAT5e)	5-PIN XLR
Common	WHITE/BROWN(PIN7) & BROWN (PIN 8)	PIN 1
Signal -	ORANGE (PIN 2)	PIN 2
Signal +	WHITE/ORANGE (PIN 1)	PIN 3
Spare	-	PIN 4
Spare	-	PIN 5

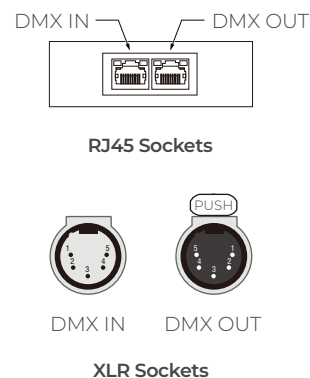

## COMPATIBLE DMX CABLING LIST

DMX uses a cable consisting of two twisted pairs plus a shield to carry data. The cable must be specifically impedance matched for the digital DMX signal, meaning that microphone cable or other non-rated cable **must not be used to carry DMX**. Network cable (Cat5, 5e or 6 cable) may be used to carry DMX in an installation; however special consideration must be given to shielding and termination. Under no circumstances should solid core cable like Cat5 be terminated into a screw down connector.

Meteor recommends the use of Belden 9729 or Belden 9841 for DMX installation. Belden 9729/9841 is a two pair cable, which allows for a spare pair for 'out and back' type terminations if needed.

REV 4 QUIET CEILING DESIGN  
HIGH LUMEN RECESSED DOWNLIGHT

DIMENSIONS

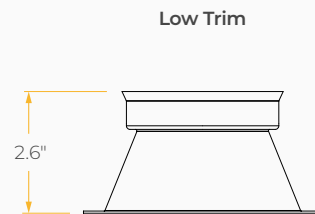
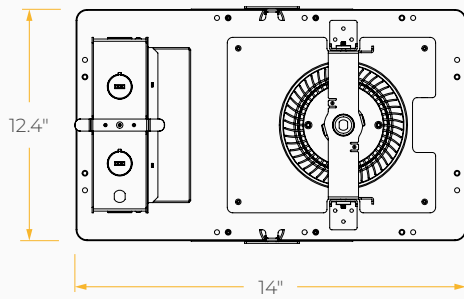
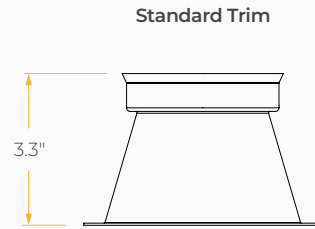
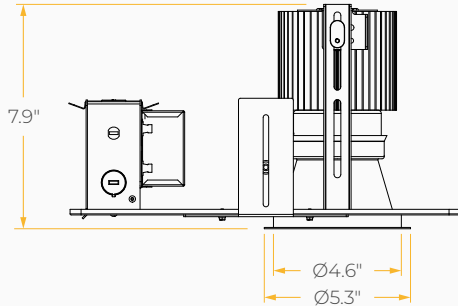

Sloped Ceiling Adapter

