

DOT 3

AESTHETIC MICROCYLINDER SMALL BEYOND COMPARE

Housing

Diameter : Ø3.5" | Height : 8.5" | Weight : 2.9 lbs

Material

Housing: High Pressure Die-Cast Aluminum
Lens: TIR Polycarbonate Lens

Power Input

10W, 15W, 25W | 120-277V

Lumen Output

1,700 lm (15W)
2,300 lm (20W)
2,900 lm (25W)

Dimming

Superior 0-10V: Dims to black
TRIAC Dims to 1% (120V Only)

Color Quality

CRI 85, CRI 93 | UGR ≤ 19

Rated Life

> 60,000 Hours (L70)

Finish



Color Temperature



Optics



Mounting



Warranty

5 Year limited warranty

Listing



One Microcylinder Family To Rule Them All

The Dot 3.5 micro cylinders come with a delivered lumen package of up to 2,920 lm. Available in black and white finishes, a variety of mounting options, and accessories.

Two years on from the introduction of the Dot series, we have now expanded the line to include even smaller apertures and greater optical, and design accessories. Offering optimal balance between diminutive design and high performance.



SPECIFICATION SHEET

DOT 3 AESTHETIC MICROCYLINDER
SMALL BEYOND COMPARE



SPECIFICATION

PROJECT NAME

DATE

CATALOG #

QUANTITY

DT3	MODEL	DOT 3		
	WATTAGE	15 15W	20 20W	25 25W
	CCT / CRI	278 2700K / CRI 85 279 2700K / CRI 93 408 4000K / CRI 85	308 3000K / CRI 85 309 3000K / CRI 93	358 3500K / CRI 85 359 3500K / CRI 93
UNV	VOLTAGE	UNV 120 – 277V		
	DIMMING	SPV Superior 0-10V dims to black	TRC TRIAC dims to 1% (120V Only)	
	BEAM ANGLE	20 20° 60 60°	25 25°	45 45°
	FINISH	BLK Black	WHT White	
	MOUNTING	ST2 Stem Mount 2ft SUM Surface Mount	ST4 Stem Mount 4ft	CM10 Cord Mount 10ft
	ACCESSORIES*	HC¹ Hex Cell Louver	SL² Solite Lens	

¹ Please factor in change in lumen output of -30%

² Please factor in change in lumen output of -15%

* Only one accessory can be chosen

SPECIFICATION SHEET

DOT 3 AESTHETIC MICROCYLINDER
SMALL BEYOND COMPARE

METEOR

TECHNICAL DETAILS

Electrical

- 1,700 lm (15W)
- 2,300lm (20W)
- 2,900 lm (25W)
- Power Input: Universal (120/277V)
- Operating Temperature: 14°F~95°F
- Surge Protection: Built-in is 2.5KV
- Integral Driver on all product configurations

LED Features

- Color Temperature: 2700K, 3000K, 3500K, 4000K
- CRI ≥ 85, CRI 93
- UGR ≤ 19
- Long life LED system designed for typical TM21 lumen maintenance ≥ L70 @ 60,000Hours

Optics

- TIR Polycarbonate Lens
- Precision molded high transmittance clear PC lenses
- Beam Angle: 20°, 25°, 45°, 60°

Advanced Dimming

- Proprietary VX Driver™ is incorporated to all dimming options for video flicker-free lighting
- Superior 0-10V dims to black
- TRIAC Dims to 1% (120V Only)

Housing

- Diameter: Ø3.5"
- Height: 8.5"
- Material: High Pressure Die-Cast Aluminum
- Weight: 2.9 lbs

Mounting

- Stem Mount 2ft or 4ft
- Cord Mount 10ft
- Surface Mount

Warranty

- 5-year limited warranty

Listing

- ETL Damp Location Listed
- CE
- FCC
- Title 24 Compliant

DELIVERED LUMENS*

	STD (Standard)			
CCT/WATTAGE	2700K	3000K	3500K	4000K
15W	1,605lm	1,690lm	1,730lm	1,750lm
20W	2,140lm	2,260lm	2,310lm	2,340lm
25W	2,675lm	2,820lm	2,880lm	2,920lm

	Current Consumption	
WATTAGE / VOLT	120V	277V
15W	0.14A	0.06A
20W	0.18A	0.08A
25W	0.24A	0.11A

*Beam Angle: 60° *Tolerance ±8%

SPECIFICATION SHEET

DOT 3 AESTHETIC MICROCYLINDER
SMALL BEYOND COMPARE

METEOR

PHOTOMETRICS

Below is a typical photometric representation of the Dot 3 fixture. Please download IES files to ensure exact photometric value.

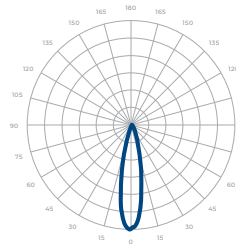

20°

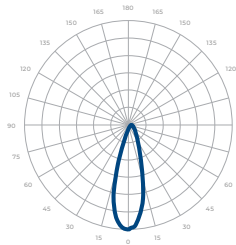

25°

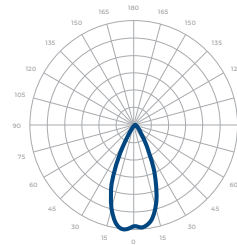

45°

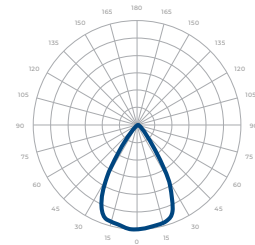

60°

ACCESSORIES

Hex Cell Louver

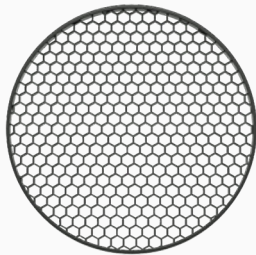

Solite Lens

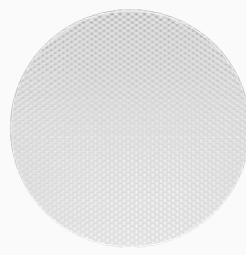

SPECIFICATION SHEET

DOT 3 AESTHETIC MICROCYLINDER
SMALL BEYOND COMPARE



DIMENSIONS

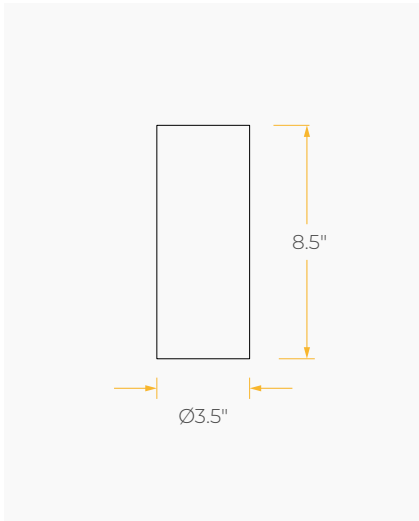

MOUNTING OPTIONS*

**Junction Box not included*

