

DOT 1

AESTHETIC MICROCYLINDER SMALL BEYOND COMPARE

Housing

Diameter : Ø1.2", Ø1.8" | Height : 12" | Weight : 1.3 lbs

Material

Housing: Extruded Aluminum
Lens: TIR Acrylic Lens

Power Input

6W, 10W | 120-277V

Lumen Output

510 lm (6W)
1,050 lm (10W)

Dimming

Superior 0-10V: dims to 1%, dims to dark

Color Quality

CRI 85, CRI 93 | UGR ≤ 19

Rated Life

> 60,000 Hours (L70)

Finish



Black



White

Color Temperature



2700K



3000K



3500K



4000K

Optics



15°



25°



30°



40°



55°

Mounting



Stem
Mount



Cord
Mount



Surface
Mount

Warranty

5 Year limited warranty

Listing



One Microcylinder Family To Rule Them All

The Dot 1 are micro cylinders with a delivered lumen package of up to 1,050 lm. Available in black and white finishes, a variety of mounting options, and decorative accessories.

Two years on from the introduction of the Dot series, we have now expanded the line to include even smaller apertures and greater optical, and design accessories. Offering optimal balance between diminutive design and high performance.



SPECIFICATION SHEET

DOT 1 AESTHETIC MICROCYLINDER
SMALL BEYOND COMPARE



SPECIFICATION

PROJECT NAME

DATE

CATALOG #

QUANTITY

DTI	MODEL	DOT 1		
	WATTAGE	6 6W (Ø1.2" Aperture)	10 10W (Ø1.8" Aperture)	
	CCT / CRI	278 2700K / CRI 85 279 2700K / CRI 93 408 4000K / CRI 85	308 3000K / CRI 85 309 3000K / CRI 93	358 3500K / CRI 85 359 3500K / CRI 93
UNV	VOLTAGE	UNV 120 – 277V		
SPV	DIMMING	SPV Superior 0-10V dims to 1%, dims to dark		
	BEAM ANGLE	15¹ 15° 40 40°	25 25° 55 55°	30² 30°
	FINISH	BLK Black	WHT White	
	MOUNTING	ST2 Stem Mount 2ft SUM Surface Mount	ST4 Stem Mount 4ft	CM10 Cord Mount 10ft
	ACCESSORIES	NO No Accessories FA2L^{3,5} Frosted Acrylic Lens 2" CA4L^{3,5} Clear Acrylic Lens 4"	HC^{3,5} Hex Cell Louver FA4L^{3,5} Frosted Acrylic Lens 4" FCS Field Cut Stem Adapter Kit	SL^{4,5} Solite Lens CA2L^{3,5} Clear Acrylic Lens 2"

¹ Option is only compatible with 10W

² Option is only compatible with 6W

³ Please factor in change in lumen output of -40%

⁴ Please factor in change in lumen output of -30%

⁵ Only one accessory can be chosen

SPECIFICATION SHEET

DOT 1 AESTHETIC MICROCYLINDER
SMALL BEYOND COMPARE

METEOR

TECHNICAL DETAILS

Electrical

- 510 lm (6W)
- 1,050 lm (10W)
- Power Input: Universal (120-277V)
- Operating Temperature: 14°F~95°F
- Surge Protection: Built-in is 2.5KV
- Remote driver on all product configurations
- Please contact factory for integral driver option

LED Features

- Color Temperature: 2700K, 3000K, 3500K, 4000K
- CRI 85, CRI 93
- UGR ≤ 19
- Long lasting LED luminaire tested under TM21 lumen maintenance L70 @ 60,000 Hrs

Optics

- TIR Acrylic Lens
- Beam Angle: 15°, 25°, 30°, 40°, 55°

Advanced Dimming

- Proprietary VX Driver™ is incorporated to all dimming options for video flicker-free lighting
- Superior 0-10V: dims to 1%, dims to dark

Housing

- Diameter: Ø1.2", Ø1.8"
- Height: 12"
- Material: Extruded Aluminum
- Weight: 1.3 lbs

Mounting

- Stem Mount 2ft or 4ft
- Cord Mount 10ft
- Surface Mount

Warranty

- 5-year limited warranty

Listing

- ETL Damp Location Listed
- CE
- FCC
- JA8 Title 24 Compliant

PERFORMANCE SUMMARY*

STD (Standard)				
CCT/WATTAGE	2700K	3000K	3500K	4000K
6W	470lm	490lm	500lm	510lm
10W	960lm	1,010lm	1,040lm	1,050lm

Current Consumption		
WATTAGE / VOLT	120V	277V
6W	0.06A	0.03A
10W	0.09A	0.04A

*Beam Angle: 55° *Tolerance ±8%

SPECIFICATION SHEET

DOT 1 AESTHETIC MICROCYLINDER
SMALL BEYOND COMPARE

METEOR

PHOTOMETRICS

Below is a typical photometric representation of the Dot 1 fixture. Please download IES files to ensure exact photometric value.

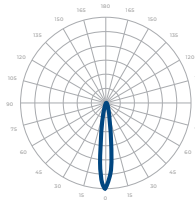

15°

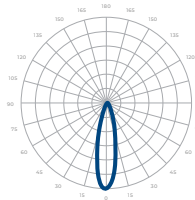

25°

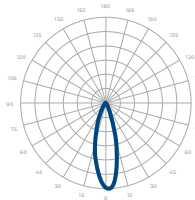

30°

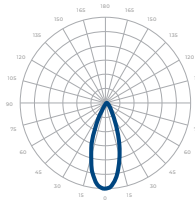

40°

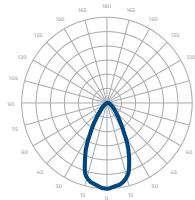

55°

ACCESSORIES

Hex Cell Louver

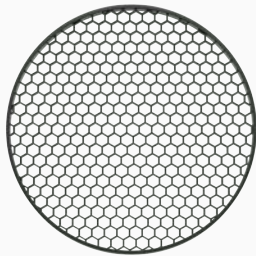

Solite Lens

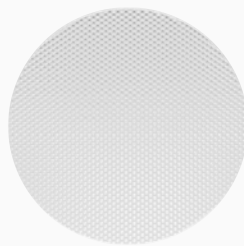

Frosted Acrylic Lens



Clear Acrylic Lens



SPECIFICATION SHEET

DOT 1 AESTHETIC MICROCYLINDER
SMALL BEYOND COMPARE



DIMENSIONS

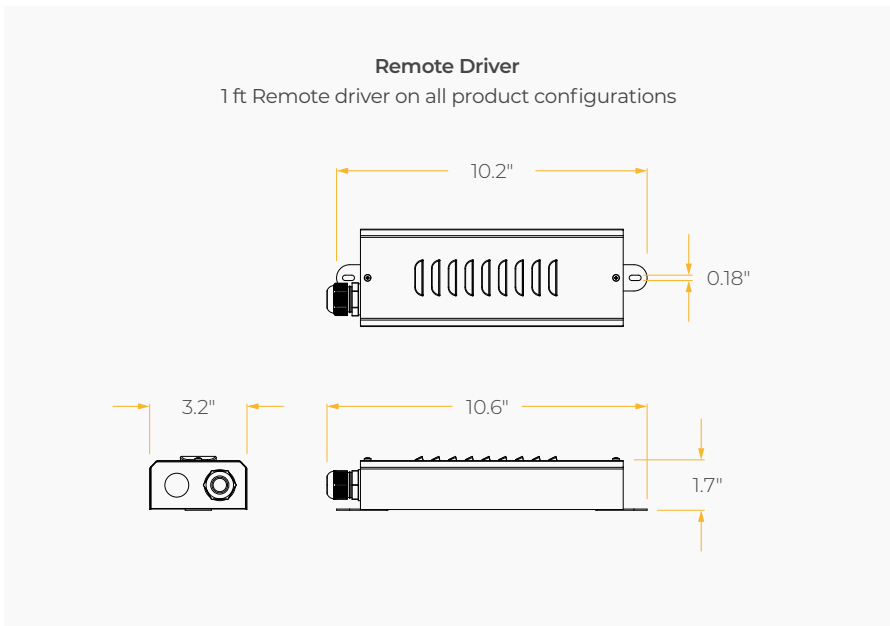
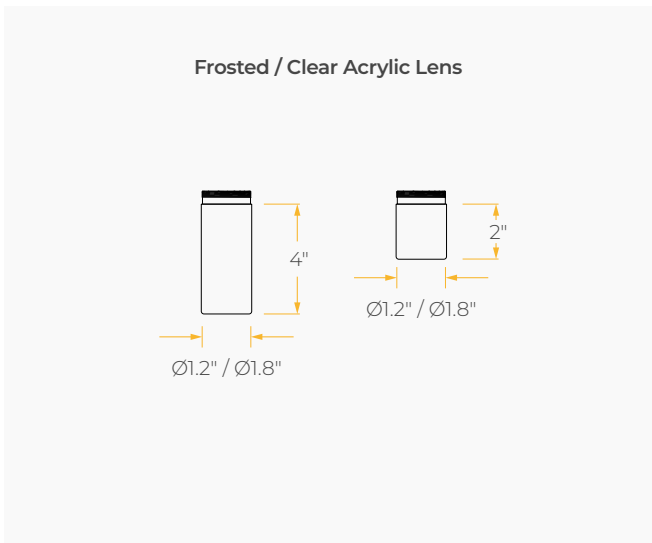
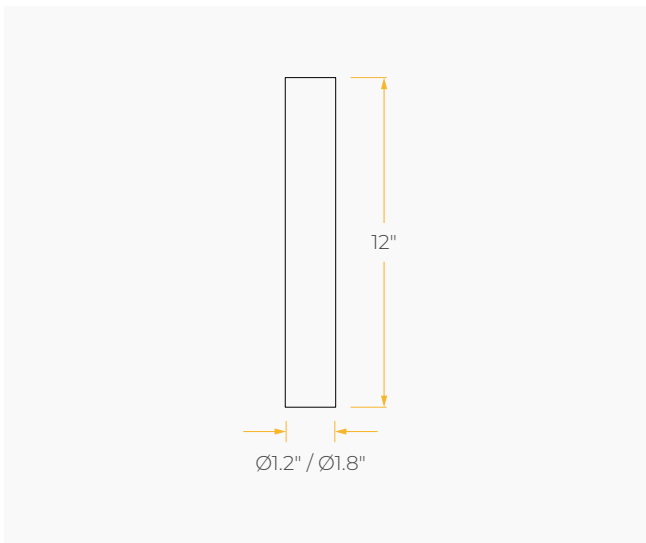

SPECIFICATION SHEET

DOT 1 AESTHETIC MICROCYLINDER
SMALL BEYOND COMPARE



MOUNTING OPTIONS*

**Junction Box not included*

