

DEXT MINI SERIES

INSTALLATION GUIDE

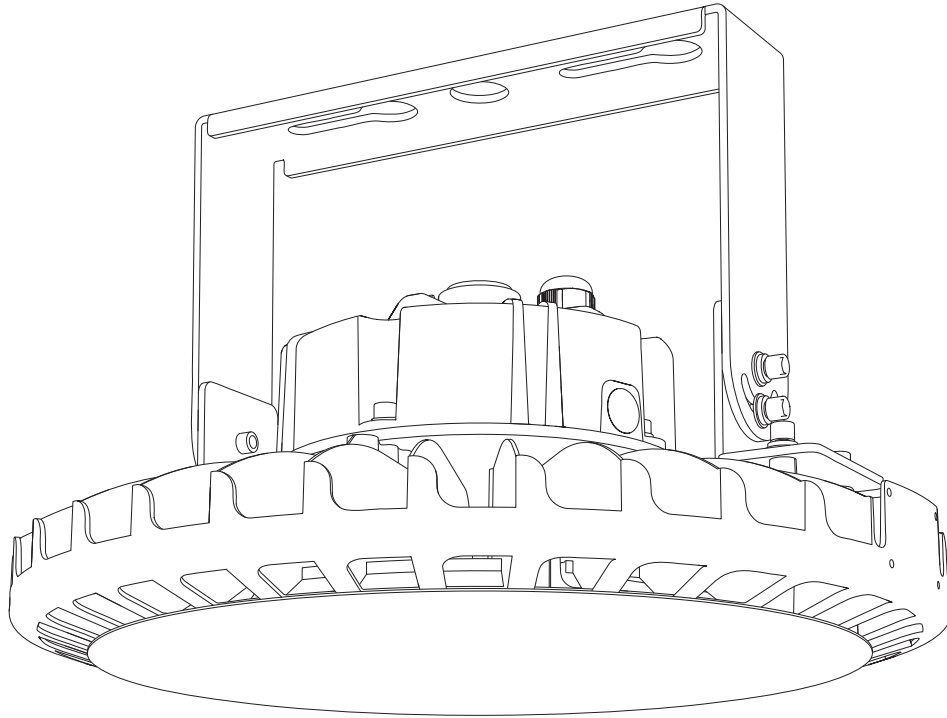

IMPORTANT SAFETY INFORMATION READ AND FOLLOW ALL SAFETY INSTRUCTIONS

- Before wiring to power supply and during servicing or relamping, turn off power at fuse or circuit breaker.
- All servicing or relamping must be performed by qualified service personnel.
- Product must be grounded to avoid potential electric shock or other potential hazard.
- Product must be installed at locations and heights, in a manner consistent with its intended use, and in compliance with Electrical Code and local codes.

SAVE THESE INSTRUCTIONS FOR FUTURE REFERENCE

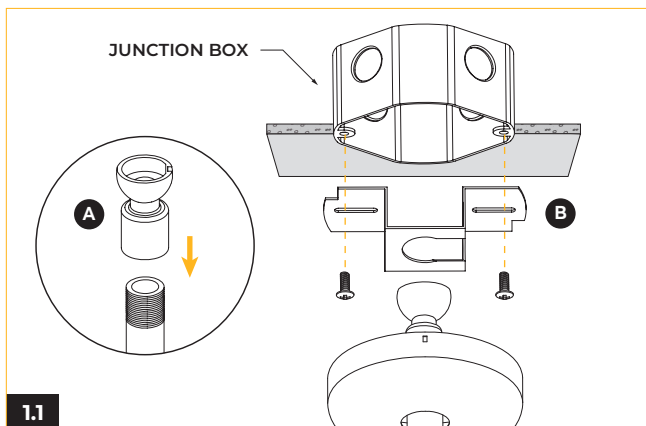

- 1.1**
- (A) Secure half ball with stem.
 - (B) Attach swivel crossbar to junction box (by others).
 - (C) Feed the safety cable and power cord through the stem and insert half ball joint into slot on swivel crossbar. Align the slot on ball joint with the tab on the swivel crossbar.
 - (D) Make electric connection in junction box according to the wiring diagram.
 - (E) Install canopy cover by aligning the tabs on crossbar with slots in the cover.

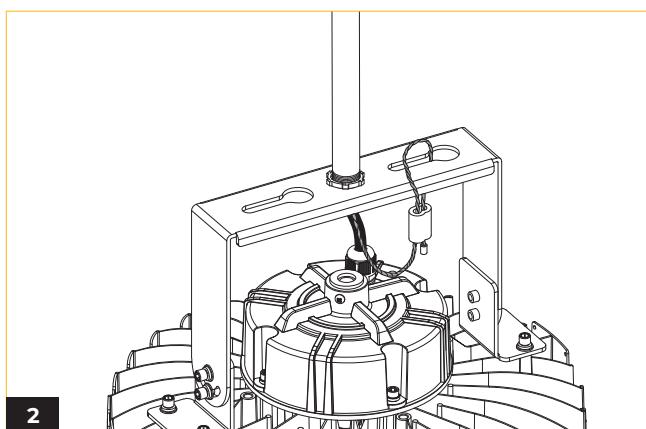
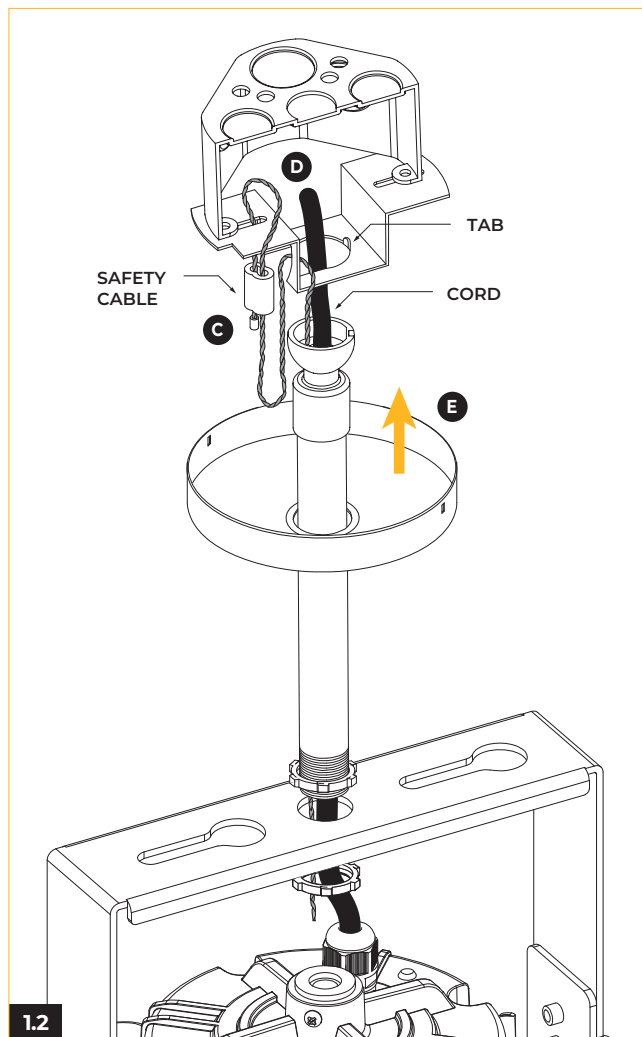

2 Clasp safety cable onto allocated slots on fixture bracket mount.

WIRING DIAGRAM

NOD (Non Dimming)

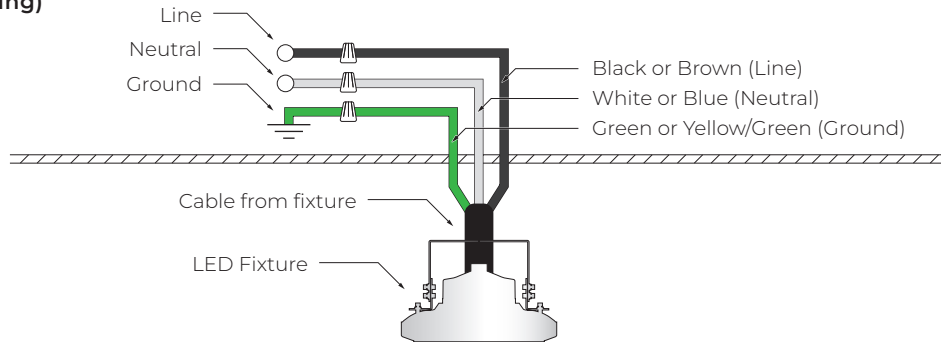

STV 0-10V

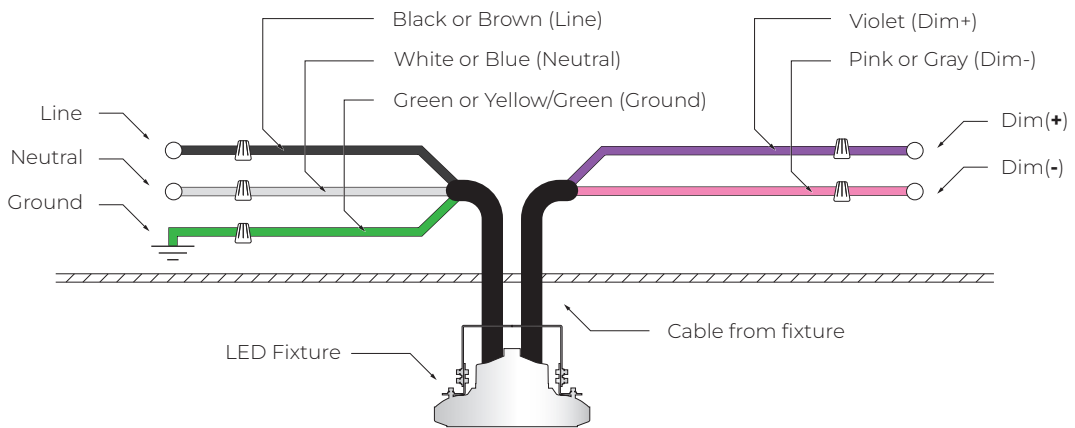

SPD (Surge Protector)

