

# ATRIA 4

SPECIFICATION SHEET  
STANDARD

## QUIET CYLINDER WITH PRISMATIC LENS

### Housing

Diameter : Ø4.8" | Height : 13" | Weight : 8 lbs

### Material

Housing: High Pressure Die-Cast Aluminum  
Lens: Clear Polycarbonate

### Power Input

15W, 25W, 35W, 45W, 65W | 120-277V

### Lumen Output

1,500 lm (15W), 2,205 lm (25W), 2,690 lm (35W), 4,305 lm (45W)  
5,650 lm (65W)

### Dimming

Standard 0-10V : Dims to 10%  
Superior 0-10V : Dims to 1%  
DMX : High resolution dims to 0.1%  
TRC : Linear line-voltage phase control, dims to 1%  
LDE1 : Hi-Lume 1% EcoSystem  
DALI : Dims to 10%

### Color Quality

CRI 85, CRI 93

### Rated Life

> 60,000 Hours (L70)

### Finish

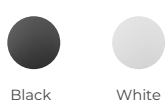

### Color Temperature

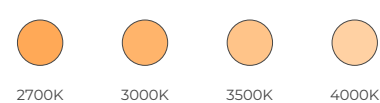

### Optics

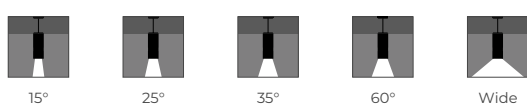

### Mounting



### Warranty

5 Year limited warranty

### Listing



Masterfully engineered and aesthetically refined.

The Atria 4 is a high-performing cylinder for mixed applications. The cylinder is compatible with our Archi-Color™ color-changing technologies, and feature decorative options in the glow ring and mid-lit reveal.

A prismatic lens offers superior light transmission and minimizes glare.



METEOR

meteor-lighting.com

**SPECIFICATION**

<b>PROJECT NAME</b>	<b>DATE</b>
<input type="text"/>	<input type="text"/>
<b>CATALOG #</b>	<b>QUANTITY</b>
<input type="text"/>	<input type="text"/>

<b>AS4</b>	<b>MODEL</b>	<b>ATRIA 4</b>		
<input type="text"/>	<b>WATTAGE</b>	<b>15</b> 15W <b>45</b> 45W	<b>25</b> 25W <b>65</b> 65W	<b>35</b> 35W
<input type="text"/>	<b>CCT / CRI</b>	<b>278</b> 2700K / CRI 85 <b>309</b> 3000K / CRI 93 <b>408</b> 4000K / CRI 85	<b>279</b> 2700K / CRI 93 <b>358</b> 3500K / CRI 85	<b>308</b> 3000K / CRI 85 <b>359</b> 3500K / CRI 93
<b>UNV</b>	<b>VOLTAGE</b>	<b>UNV</b> 120 – 277V		
<input type="text"/>	<b>DIMMING</b>	<b>STV</b> Standard 0-10V dims to 10% <b>DMX(RJ45)<sup>1</sup></b> DMX dims to 0.1% (RJ45 Sockets) <b>DALI<sup>3</sup></b> DALI dims to 10%	<b>SPV</b> Superior 0-10V dims to 1% <b>TRC<sup>2</sup></b> Linear line-voltage phase control, dims to 1%	<b>DMX<sup>1</sup></b> DMX dims to 0.1% (XLR Sockets) <b>LDE1<sup>3</sup></b> Hi-Lume 1% EcoSystem LED Driver with Soft-on, Fade-to-Black (UNV only)
<input type="text"/>	<b>BEAM ANGLE</b>	<b>15</b> 15° <b>60</b> 60°	<b>25</b> 25° <b>WD<sup>4</sup></b> Wide	<b>35</b> 35°
<input type="text"/>	<b>FINISH</b>	<b>BLK</b> Black	<b>WHT</b> White	
<input type="text"/>	<b>RIM FINISH</b>	<b>STD</b> Standard Trim	<b>GLR</b> Glow Ring	<b>MLT<sup>5</sup></b> Mid-Lit Trim
<input type="text"/>	<b>MOUNTING</b>	<b>SUM</b> Surface Mount <b>AD10</b> Adjustable Cable 10ft <b>SAD10</b> Sloped Adjustable Cable 10ft	<b>ST2</b> Stem 2ft <b>WLM<sup>5</sup></b> Wall Mount	<b>ST4</b> Stem 4ft <b>YKM</b> Yoke Mount
<input type="text"/>	<b>ACCESSORIES</b>	<b>NO</b> No Accessories <b>CT<sup>7</sup></b> Conduit Mount <b>AWW<sup>9</sup></b> Lutron Athena Wireless Module White	<b>EMP</b> Remote Emergency Pack <b>FCS<sup>8</sup></b> Field Cut Stem Adapter Kit <b>NXB<sup>10</sup></b> NX Radio Module Black	<b>DF<sup>6</sup></b> Diffuser <b>AWB<sup>9</sup></b> Lutron Athena Wireless Module Black <b>NXW<sup>10</sup></b> NX Radio Module White

<sup>1</sup> DMX option not compatible with WLM, 65W  
<sup>2</sup> Option is only compatible with 120V and not compatible with 45W, 65W.  
<sup>3</sup> Option is not compatible with 65W  
<sup>4</sup> Please factor in change in lumen output of -20% with WD  
<sup>5</sup> MLT not compatible with 65W  
<sup>6</sup> Please factor in change in lumen output with Diffuser (-20% with WD; -12% with other degrees)  
<sup>7</sup> CT only compatible with ST and AD mounting types  
<sup>8</sup> Option is not compatible with outdoor or natatorium configurations  
<sup>9</sup> Option is only compatible with STV, SPV, DALI  
<sup>10</sup> Option is only compatible with STV, SPV

**TECHNICAL DETAILS**

**Electrical**

- 1,500 lm (15W), 2,205 lm (25W), 2,690 lm (35W)  
4,305 lm (45W), 5,650 lm (65W)
- Power Input: Universal (120-277V)
- Operating Temperature: -13°F~104°F
- Surge Protection: Built-in is 4KV
- Emergency Pack with Mounting Plate: Bodine BSL20B2UEK55C11

**LED Features**

- Color Temperature: 2700K, 3000K, 3500K, 4000K
- CRI 85, CRI93
- Long lasting LED luminaire tested under TM21 lumen maintenance L70 @ 100,000 Hrs
- Lumen Maintenance > 0.90 at 60,000 hours

**Optics**

- Precision molded high transmittance clear PC lens
- Beam Angle: 15°, 25°, 35°, 60°, Wide

**Advanced Dimming**

- Proprietary VX Driver™ is incorporated to all dimming options for video flicker-free lighting
- Standard 0-10V: Dims to 10%
- Superior 0-10V: Dims to 1%
- DMX: High resolution dims to 0.1% (Supports ANSI E1.20 RDM protocol)
- TRC: Linear line-voltage phase control, dims to 1% (120V only)
- LDEI: Hi-Lume 1% EcoSystem LED Driver with Soft-on, Fade-to-Black (UNV only)
- DALI: Dims to 10%

**Housing**

- Diameter: Ø4.8"
- Height: 12.6"
- Material: High Pressure Die-Cast Aluminum, PC Lens
- Weight: 8 lbs

**Mounting**

- Surface Mount
- Stem 2ft or 4ft; 45° Swivel Canopy Included
- Adjustable Cable 10ft
- Sloped Adjustable Aircraft Cable 10ft
- Yoke Mount
- Wall Mount

**Warranty**

- 5-year limited warranty

**Listing**

- ETL Damp Location Listed
- CE
- FCC
- UKCA
- Energy Star Rated

**PERFORMANCE SUMMARY\***

Delivered Lumens				
CCT/WATTAGE	2700K	3000K	3500K	4000K
<b>15W</b>	1,340lm	1,380lm	1,460lm	1,500lm
<b>25W</b>	1,990lm	2,060lm	2,180lm	2,205lm
<b>35W</b>	2,400lm	2,480lm	2,620lm	2,690lm
<b>45W</b>	3,720lm	3,980lm	4,210lm	4,305lm
<b>65W</b>	5,120lm	5,280lm	5,590lm	5,650lm

Current Consumption		
WATTAGE / VOLT	120V	277V
<b>15W</b>	0.17A	0.08A
<b>25W</b>	0.23A	0.11A
<b>35W</b>	0.34A	0.15A
<b>45W</b>	0.45A	0.2A
<b>65W</b>	0.64A	0.29A

\*Beam Angle: 25° \* Tolerance ±8%

Emergency Pack Lumen Output Table				
CCT	2700K	3000K	4000K	5000K
<b>LUMEN</b>	1,640lm	1,760lm	1,890lm	1,950lm

**PHOTOMETRICS**

Below is a typical photometric representation of the Atria 4 fixture. Please download IES files to ensure exact photometric value.

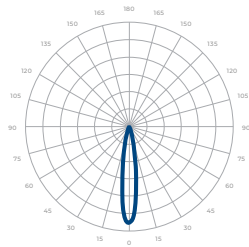

15°

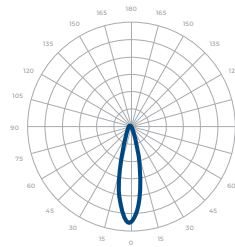

25°

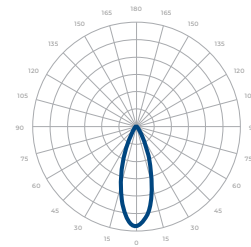

35°

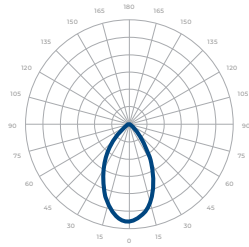

60°

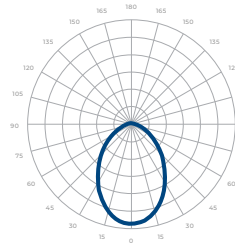

Wide

**DMX REQUIREMENTS**

The Atria 4 fixture with DMX is a **single channel dmx** unit. When placing an order, please indicate DMX address. (The DMX address will be listed on the back of the fixture). Do not connect more than 32 fixtures per DMX daisy chain.

The fixture can be connected with RJ45 or XLR sockets. DMX cables **are not** included; please refer to compatible DMX cabling list for more information. The final fixture on each daisy chain should be terminated by the use of a DMX terminator purchased from a 3rd party or from Meteor.

CONNECTION	RJ45 (CAT5e)	5-PIN XLR
Common	WHITE/BROWN(PIN7) & BROWN (PIN 8)	PIN 1
Signal -	ORANGE (PIN 2)	PIN 2
Signal +	WHITE/ORANGE (PIN 1)	PIN 3
Spare	-	PIN 4
Spare	-	PIN 5

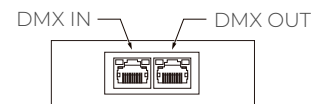

RJ45 Sockets



XLR Sockets

**COMPATIBLE DMX CABLING LIST**

DMX uses a cable consisting of two twisted pairs plus a shield to carry data. The cable must be specifically impedance matched for the digital DMX signal, meaning that microphone cable or other non-rated cable **must not be used to carry DMX**. Network cable (Cat5, 5e or 6 cable) may be used to carry DMX in an installation; however special consideration must be given to shielding and termination. Under no circumstances should solid core cable like Cat5 be terminated into a screw down connector.

Meteor recommends the use of Belden 9729 or Belden 9841 for DMX installation. Belden 9729/9841 is a two pair cable, which allows for a spare pair for 'out and back' type terminations if needed.

**COMPATIBLE LDE1 DIMMER LIST**

LUTRON PART NO.						
RMJ-ECO32-DV-B	FCJ/FCJS-ECO	QSN-1ECO-S	QSN-2ECO-S	QSGRJ-_E	QSGR-_E	QP2-__ 2C
QP2-__ 4C	QP2-__ 6C	QP2-__ 8C	LQSE-2ECO-D			

**COMPATIBLE TRC DIMMER LIST**

PART NO.					
Lutron S-603PG	Lutron DVCL-153P	Lutron DVLV-600P	Lutron TGCL-153P	Lutron S-600P	Lutron DVELV-303P
Lutron SELV-300P	Lutron TG-600P	Lutron DVLV-600P	Lutron LG-600P	Lutron CT-103P	Lutron MAELV-600
Lutron FAELV-500	Leviton IPI06-1LZ	Leviton 6631-2	Leviton VPE06	Leviton 6683-IW	Leviton 6161
Leviton 6633-P	Leviton IPE04	Cooper DLC03P	Cooper SLC03P	Cooper DAL06P	Lightolier ZP260QEW

**RIM FINISH**

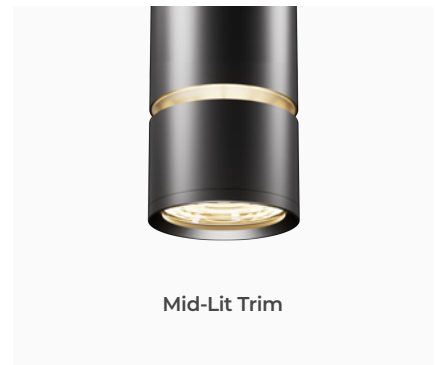
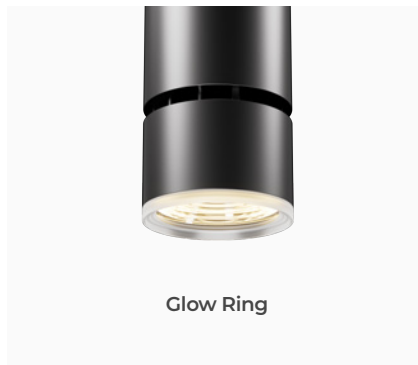
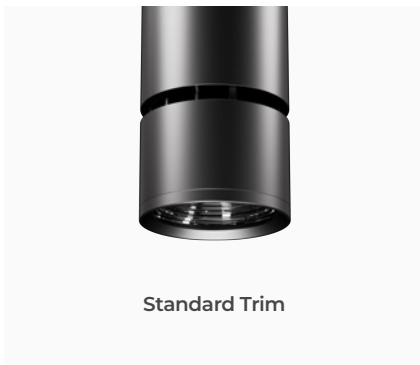

**DIMENSIONS**

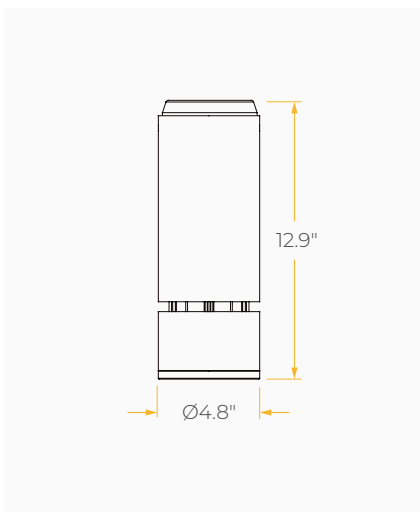

**DIMENSIONS**

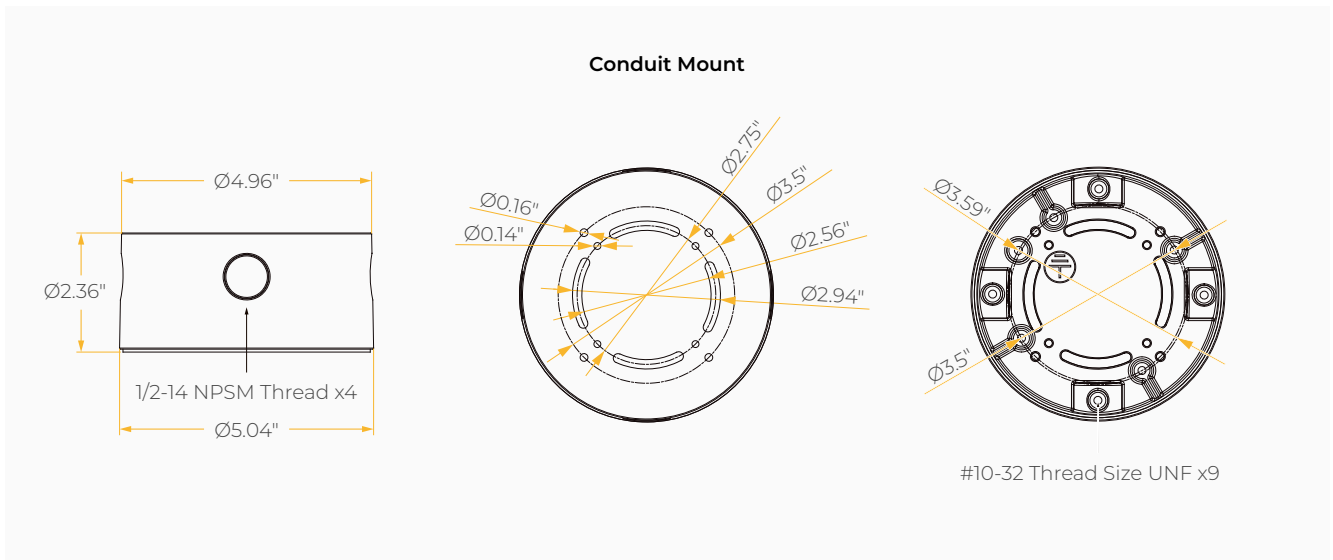
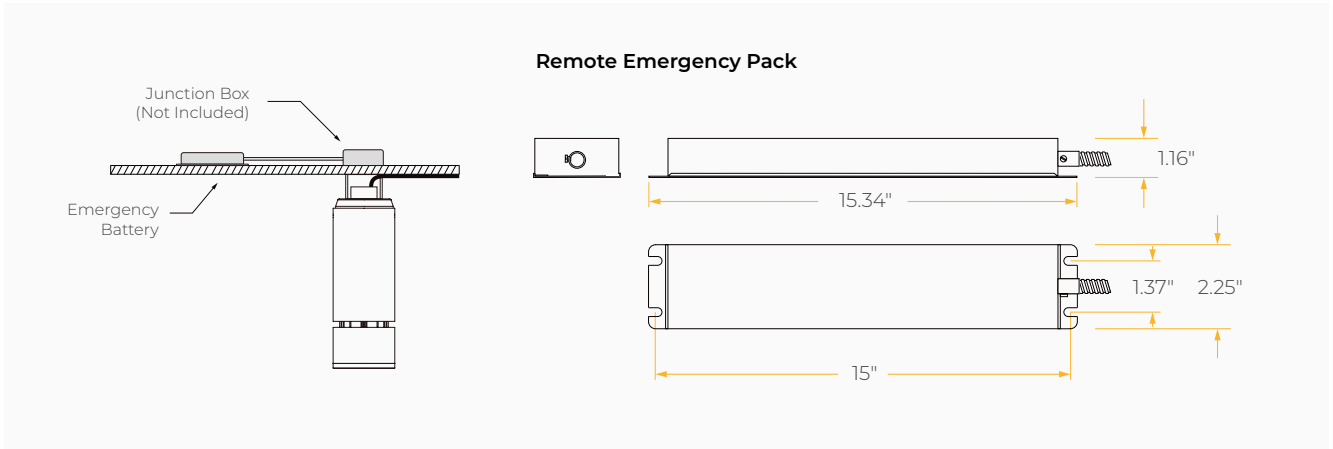

**MOUNTING OPTIONS\***

\*Junction box not included

