

ADVANCED HIGH CEILING

Atria 10 - Tunable White Version



10-inch Cylinder utilizing Meteor Lighting's proprietary ColorFlip™ Tunable White solution, that results in superior efficacy and heat management. This product is compatible with all existing 0-10V and DMX control systems. Bringing human centric lighting to your spaces.

Quantity		Type	
Project		Note	

Delivered Lumens*

ColorFlip™ CCT Signal (%)	2700K	3000K	3500K	4000K	4500K	5000K	5700K	6500K	*Lumen Multiplier 45° baseline 55° 0.95
0-10V CCT Voltage	0	1	2.5	4.5	6	7	8.5	10	
220W	16056 lm	16960 lm	17884 lm	18788 lm	18641 lm	18473 lm	18305 lm	18158 lm	
180W	13399 lm	14154 lm	14925 lm	15679 lm	15557 lm	15416 lm	15276 lm	15153 lm	
140W	10626 lm	11224 lm	11836 lm	12434 lm	12337 lm	12226 lm	12114 lm	12017 lm	
110W	8429 lm	8904 lm	9389 lm	9864 lm	9786 lm	9698 lm	9610 lm	9533 lm	
80W	6189 lm	6537 lm	6894 lm	7242 lm	7185 lm	7120 lm	7056 lm	6999 lm	
CRI	85	86	87	88	88	87	86	85	

Electrical System

- 80W, 110W, 140W, 180W, 220W
- Power Input: Universal (120-277V)
- Operating Temperature: -13°F~112°F
- Surge Protection: 4KV
- Remote Emergency Pack: Bodine BSL20B2UEK55C111
- Power Factor Greater than 0.9

- Diameter: 9.4" (238mm)
- Height: 20.5" (520mm)
- Material: Aluminum
- Weight: 30 lbs

LED Technology

- ColorFlip™ (Tuning White: 2700K ↔ 6500K)
- 85+ CRI
- Beam Angle: 45°, 55°, WD
- Rated Life > 60,000 Hours (L70)

Mounting

- Stem 2ft or 4ft; 45° Swivel Canopy Included
- Adjustable Aircraft Cable 10ft

Warranty

- 5 years limited warranty.

Advanced Dimming

(Proprietary VX Driver is incorporated to all dimming options for video flicker-free lighting)

DMX: high resolution dims to 0.1% (2 channel)
(Supports ANSI E1.20 RDM protocol)

- Superior 0-10V: dims to 1% (2 channel)

1 channel control dimming. 1 channel control CCT.

Listing

- ETL Damp Location Listed
- FCC
- CE



Housing

METEOR LIGHTING P: 213.255.2060 F: 213.596.3704 www.meteor-lighting.com

Atria 10 - Tunable White Version



How To Specify:

Ordering Example: AS10-80-TNW-UNV-DMX-45-WHT-AD10

4-5 weeks lead time on over 75% of specifications.

Model	Wattage	CCT / CRI	Voltage	Dimming
AS10		TNW	UNV	
AS10 Atria 10	80 80W 110 110W 140 140W 180 180W 220 220W	TNW 2700K / CRI85	UNV 120-277V	SPV Superior 0-10V dims to 1% DMX DMX dims to 0.1% (XLR Sockets) DMX(RJ45) DMX dims to 0.1% (RJ45 Sockets)

Beam Angle	Finish	Mounting	Accessories
45 45° 55 55° WD* WIDE *Please factor in change in lumen output with diffuser (-20% with WD; -12% with other degrees).	BLK Black WHT White	ST2 Stem 2ft ST4 Stem 4ft AD10 Adjustable Cable 10ft	SPD ¹ Surge Protector HC ² Honeycomb Louver EMP ³ Remote Emergency Pack ¹ Surge protector for up to 10KV. ² Please factor in change in lumen output of 30% ³ Option not compatible with 220W

Atria 10 - Tunable White Version



Superior 0-10V Wiring Diagram

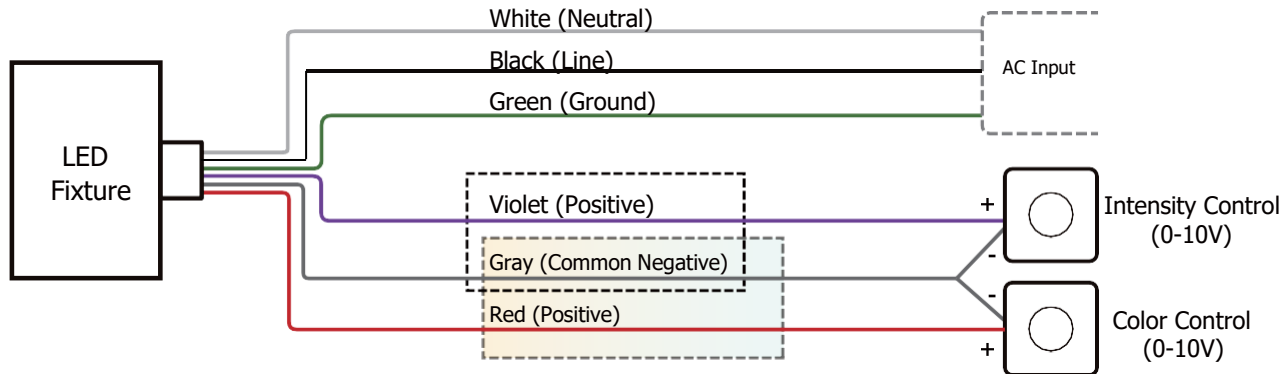

Dimensions

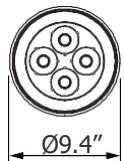
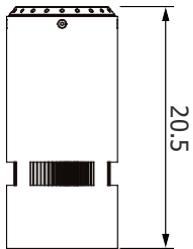

Mounting Options

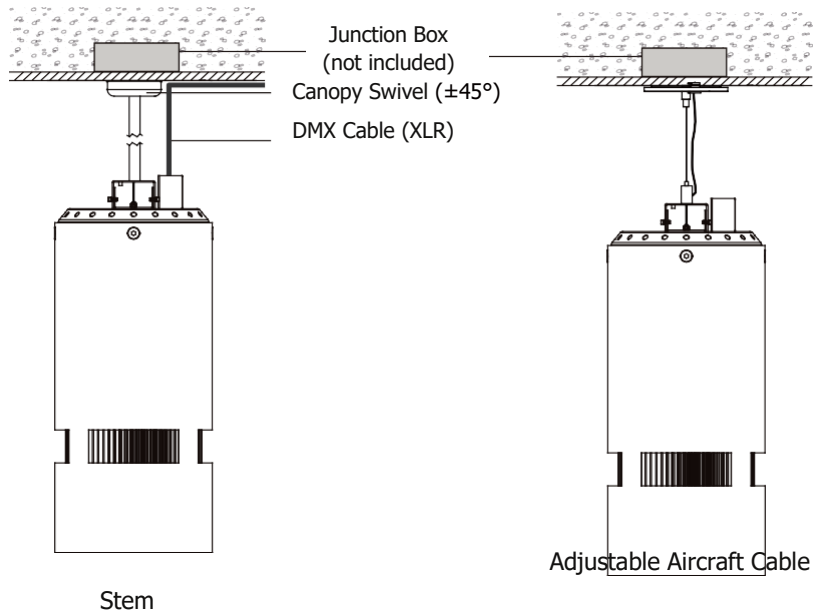

DMX Requirements*

Each Atria 10 DMX unit has TWO CHANNELS per fixture (1 to control intensity, 1 to control color).

Fixture will be controlled by DMX number controlling intensity.

We do not recommend more than 32 fixtures per DMX daisy chain.

When placing order, please indicate DMX address (refer to DMX Address example below).

DMX address will be listed on the back of each fixture.

Fixture	DMX Address	
	Intensity Control (ex. X)	Color Control (ex. X+1)
#1	1	2
#2	3	4
#3	5	6

The LED fixture provide RJ45 Socket or XLR socket to connect. (DMX cable NOT included.)

RJ45 Sockets

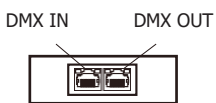

XLR Sockets

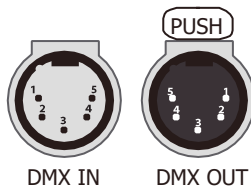

CONNECTION	RJ45 (CAT5e)	5-PIN XLR
Common	WHITE/BROWN(PIN7) & BROWN (PIN 8)	PIN 1
Signal -	ORANGE (PIN 2)	PIN 2
Signal+	WHITE/ORANGE (PIN 1)	PIN 3
Spare	-	PIN 4
Spare	-	PIN 5

Compatible DMX Cabling List

DMX uses a cable consisting of two twisted pairs plus a shield to carry data. The cable must be specifically impedance matched for the digital DMX signal, meaning that microphone cable or other non-rated cable **must not be used to carry DMX**. Network cable (Cat5, 5e or 6 cable) may be used to carry DMX in an installation; however special consideration must be given to shielding and termination. Under no circumstances should solid core cable like Cat5 be terminated into a screw down connector.

Meteor recommends the use of Belden 9729 for DMX installation. Belden 9729 is a two pair cable, which allows for a spare pair for 'out and back' type terminations if needed. Below is a list of other compatible Belden cables.

DMX Wiring Diagram

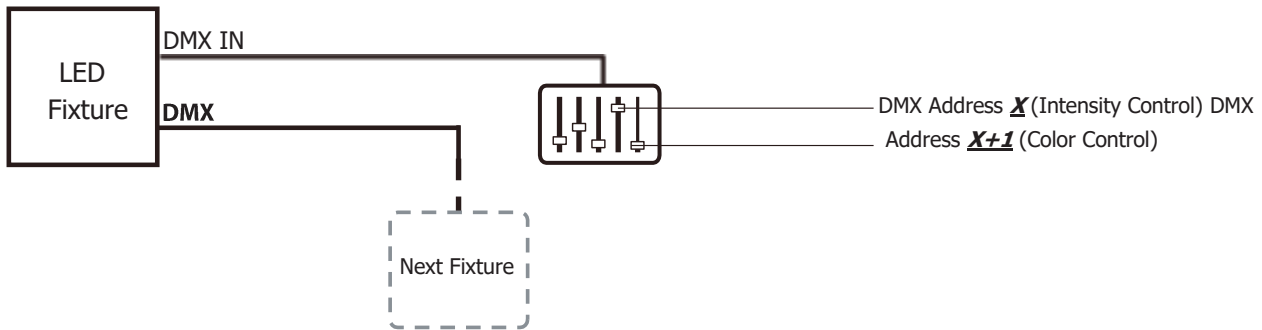

Remote Emergency Pack

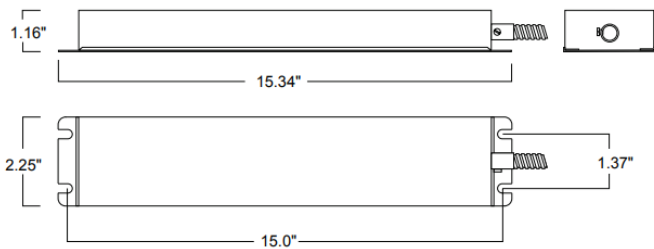

Mounting with standard ceiling recessed Junction BOX

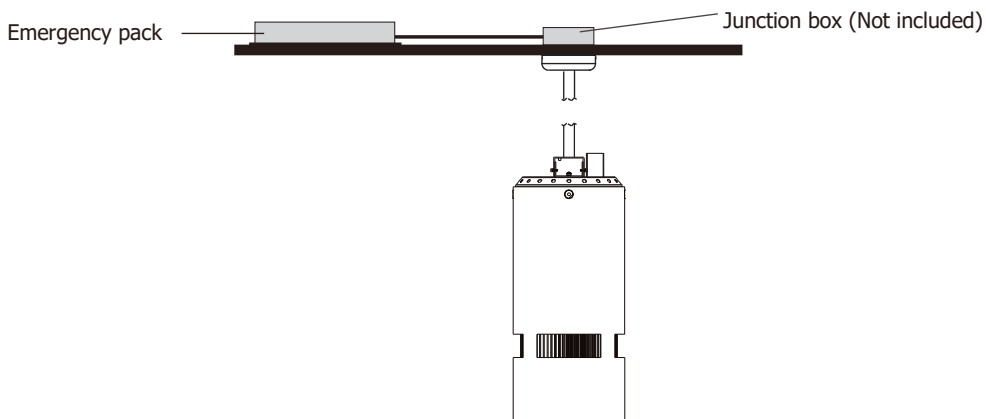

Emergency Pack Lumen Output Table

CCT	6500K
Lumen	2000 lm