

# Zeta 10 - Tunable White Version (ColorFlip™)



10-inch aperture Cylinder utilizing Meteor Lighting's proprietary ColorFlip™ Tunable White solution, that results in superior efficacy and heat management. This product is compatible with all existing 0-10V and DMX control systems. Bringing human centric lighting to your spaces.



Quantity		Type	
Project		Note	

## Delivered Lumens\*

ColorFlip™	2700K	3000K	3500K	4000K	4500K	5000K	5700K	6500K	*Lumen Multiplier 45° baseline 55° 0.95
<b>DMX</b> CCT Signal (%)	0%	10%	25%	45%	60%	70%	85%	100%	
<b>0-10V</b> CCT Voltage	0	1	2.5	4.5	6	7	8.5	10	
100W	6968 lm	7360 lm	7761 lm	8090 lm	8153 lm	8016 lm	7943 lm	7880 lm	
80W	5683 lm	6003 lm	6331 lm	6598 lm	6651 lm	6539 lm	6479 lm	6427 lm	
45W	3258 lm	3442 lm	3629 lm	3783 lm	3813 lm	3749 lm	3715 lm	3685 lm	
<b>CRI</b>	<b>85</b>	<b>86</b>	<b>87</b>	<b>88</b>	<b>88</b>	<b>87</b>	<b>86</b>	<b>85</b>	

### Electrical System

- 45W, 80W, 100W
- Power Input: Universal (120-277V)
- Operating Temperature: -13°F~112°F
- Surge Protection: 4KV
- Remote Emergency Pack: Bodine BSL20LV
- Power Factor Greater than 0.9

### LED Technology

- ColorFlip™ (Tuning White: 2700K ←→ 6500K)
- 85+ CRI
- Beam Angle: 45°, 55°
- Rated Life > 60,000 Hours (L70)

### Advanced Dimming

(Proprietary VX Driver is incorporated to all dimming options for video flicker-free lighting)

- Superior 0-10V: dims to 1% (2 channel) 1 channel control dimming. 1 channel control CCT.
- DMX: high resolution dims to 0.1% (2 channel) (Supports ANSI E1.20 RDM protocol)

### Housing

- Diameter: 9.4" (238mm)
- Height: 20.5" (520mm)
- Material: Aluminum
- Weight: 25 lbs.
- Finish Trim Options

### Mounting

- Stem 2ft or 4ft
- Adjustable Aircraft Cable 10ft

### Warranty

- 5-year limited warranty

### Listing

- ETL Damp Location Listed
- FCC
- CE



# Zeta 10 - Tunable White Version (ColorFlip™)





## How To Specify:

**Ordering Example: ZS10-80-TNW-U-DMX-45-4-W-AD10**

**4-5 weeks lead time on over 75% of specifications.**

Model	Wattage	CCT / CRI	Voltage	Dimming
ZS10			U	
ZS10	<b>45</b> 45W	<b>TNW</b> 2700 – 6500K	<b>U</b> 120-277V	<b>SPV</b> Superior 0-10V dims to 1%
Zeta 10	<b>80</b> 80W			<b>DMX</b> DMX dims to 0.1% (XLR Sockets)
	<b>100</b> 100W			<b>DMX(RJ45)</b> DMX dims to 0.1% (RJ45 Sockets)

Beam Angle	Finish	Trim Finish	Mounting	Accessories
<b>45</b> 45°	<b>BLK</b> Black	<b>1</b> Copper Color Trim	<b>ST2</b> Stem 2ft	<b>SPD<sup>1</sup></b> Surge Protector
<b>55</b> 55°	<b>WHT</b> White	<b>2</b> Gold Color Trim	<b>ST4</b> Stem 4ft	<b>EMP</b> Remote Emergency Pack
		<b>3</b> Silver Color Trim	<b>AD10</b> Adjustable Cable 10ft	
		<b>4</b> White Color Trim		
		<b>5</b> Black Color Trim		
		 <p>Color Trim</p>		
				
		1 2 3 4 5		<sup>1</sup> Surge protector for up to 10KV. Applicable for unstable mains or facilities using high power machinery.

# Zeta 10 - Tunable White Version (ColorFlip™)



## Dimensions

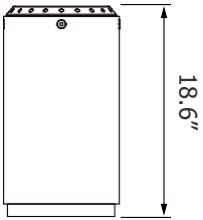

## Mounting Options

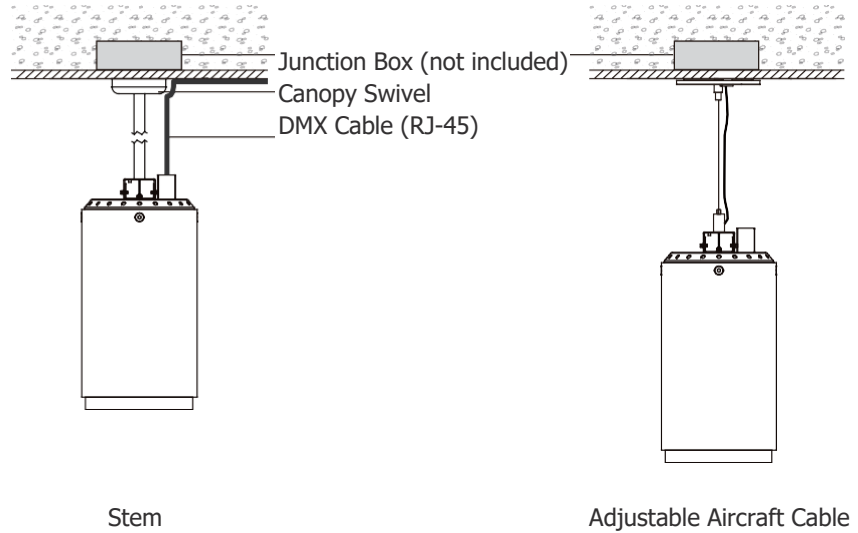

## Superior 0-10V Wiring Diagram

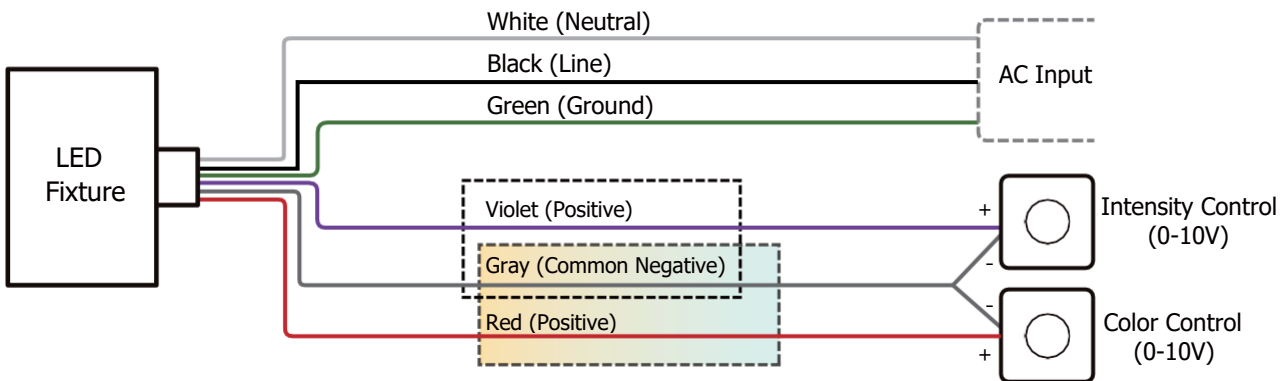

# Zeta 10 - Tunable White Version (ColorFlip™)



## DMX Requirements\*

Each Zeta 10 DMX unit has TWO CHANNELS per fixture (1 to control intensity, 1 to control color). Fixture will be controlled by DMX number controlling intensity. We do not recommend more than 32 fixture per DMX daisy chain. When placing order, please indicate DMX address (refer to DMX Address example below). DMX address will be listed on the back of each fixture.

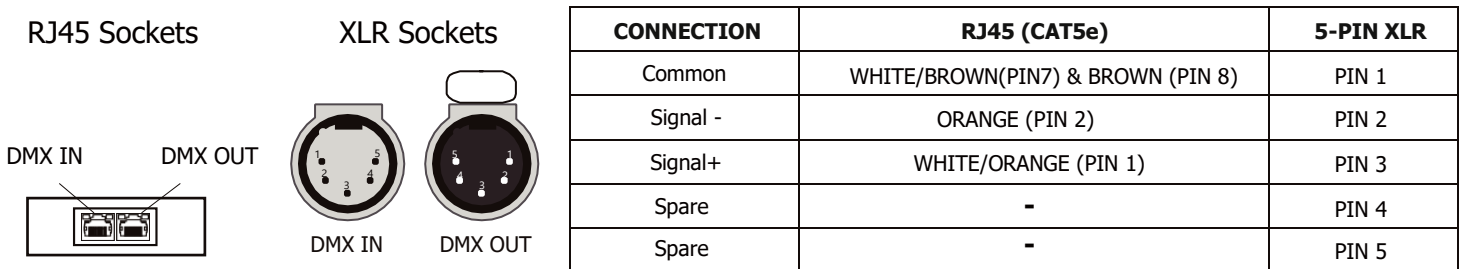
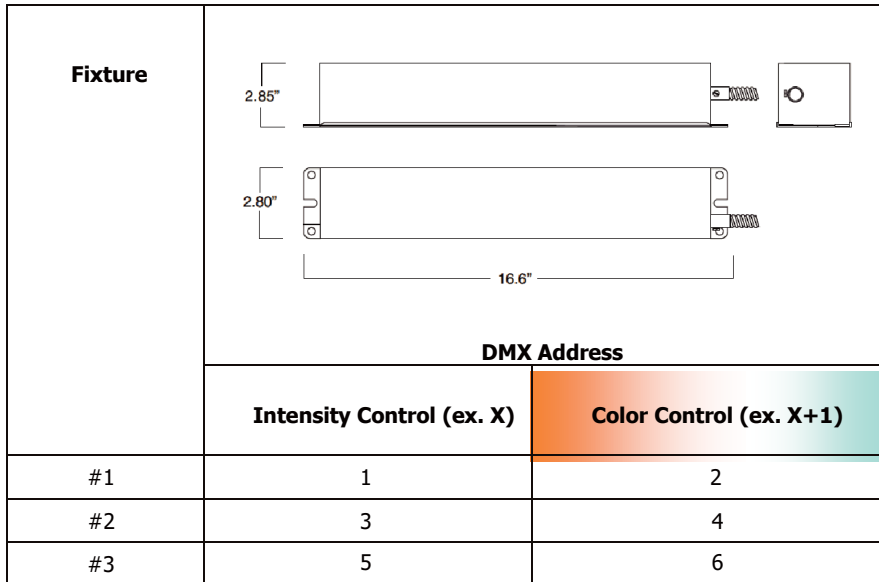

## Compatible DMX Cabling List

DMX uses a cable consisting of two twisted pairs plus a shield to carry data. The cable must be specifically impedance matched for the digital DMX signal, meaning that microphone cable or other non-rated cable **must not be used to carry DMX**. Network cable (Cat5, 5e or 6 cable) may be used to carry DMX in an installation; however special consideration must be given to shielding and termination. Under no circumstances should solid core cable like Cat5 be terminated into a screw down connector.

Meteor recommends the use of Belden 9729 for DMX installation. Belden 9729 is a two pair cable, which allows for a spare pair for 'out and back' type terminations if needed. Below is a list of other compatible Belden cables.

# Zeta 10 - Tunable White Version (ColorFlip™)



## DMX Wiring Diagram

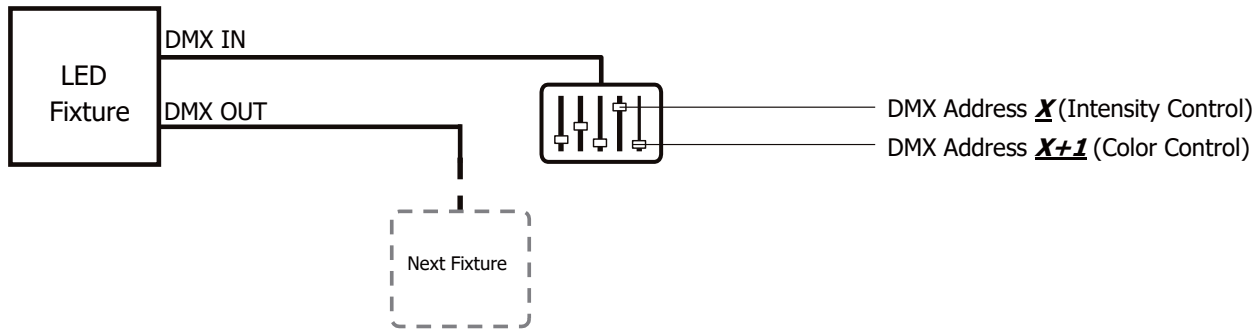

## Remote Emergency Pack

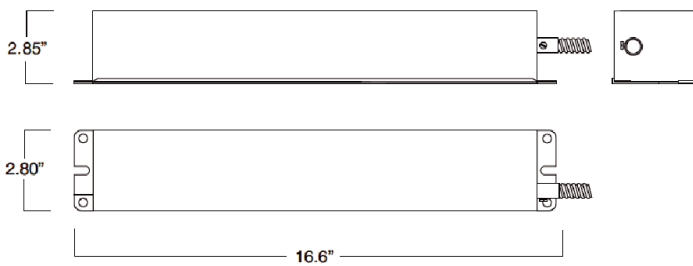

## Emergency Pack Lumen Output Table

CCT	6500
Lumen	2000 lm

## Mounting with standard ceiling recessed Junction BOX

