

ADVANCED HIGH CEILING Vela 4 - Surface Mount



IMPORTANT SAFETY INFORMATION. READ AND FOLLOW ALL SAFETY INSTRUCTIONS

IMPORTANT SAFETY INFORMATION. READ AND FOLLOW ALL SAFETY INSTRUCTIONS. Before wiring to power supply and during servicing or relamping, turn off power at fuse or circuit breaker. All servicing or relamping must be performed by qualified service personnel. Product must be grounded to avoid potential electric shock or other potential hazard. Product must be at locations and at heights and in a manner consistent with its intended use, and in compliance with Electrical Code and local codes.

SAVE THESE INSTRUCTIONS FOR FUTURE REFERENCE.

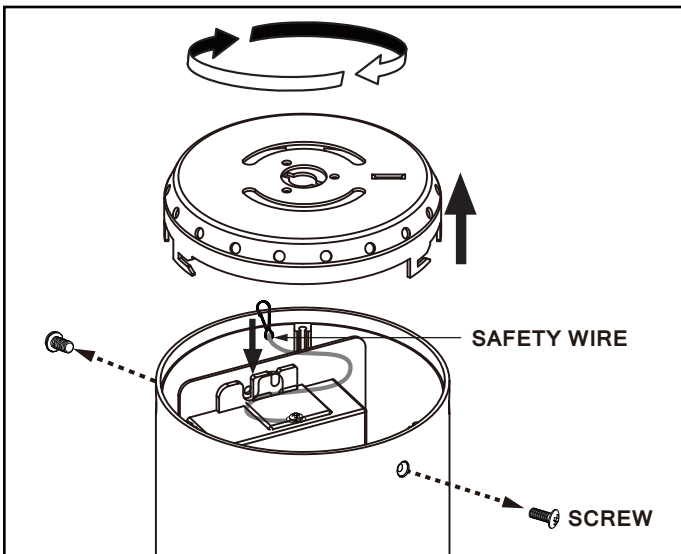

Step 1

Loosen two screws on the side of the fixture. Twist and lift up the lid from cylinder. Unhook the safety wire from cylinder to detach the lid.

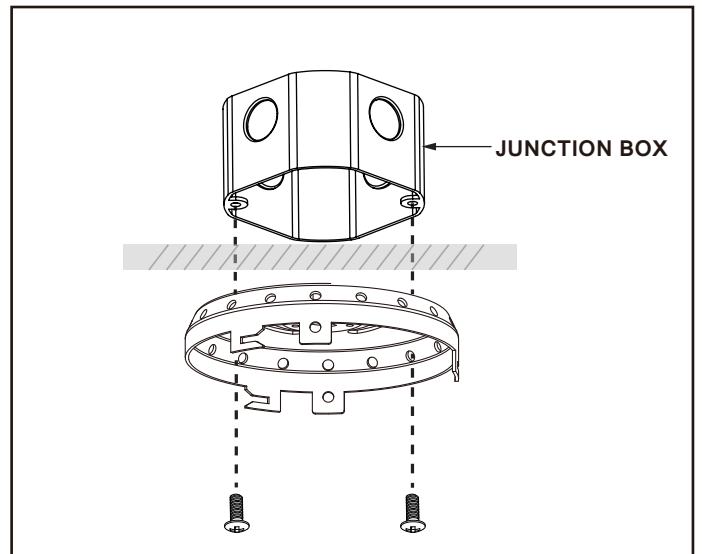

Step 2

Attach the lid directly to 4" square or octagonal junction box (by others) using hardware supplied with junction box.

ADVANCED HIGH CEILING Vela 4 - Surface Mount

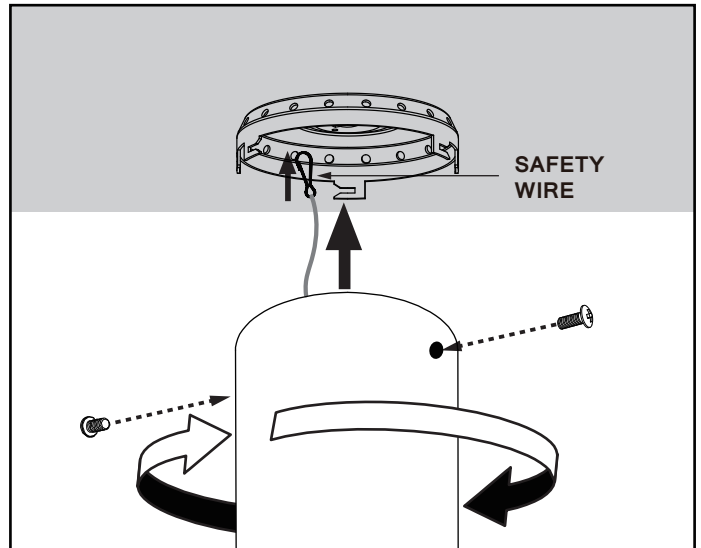
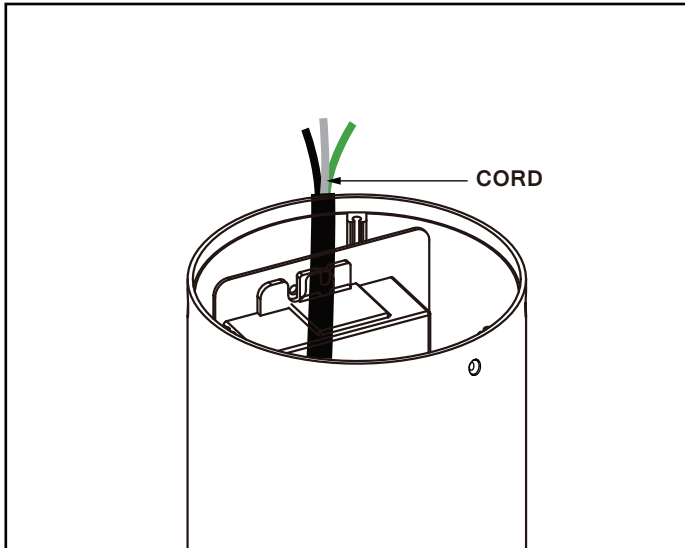

Step 3

Make electrical connections between junction box and fixture with UL listed connectors or wire nuts (by others), see wiring diagram below.

Step 4

Attach safety wires to fixture lid. Secure fixture and secure using 2 allen screws.

Wiring Diagram

0-10V / Dims to off

