

# Signum 8 - Standard



8 inch aperture high lumen with lumen output 3230 – 4220lm.



Quantity	Type
Project	Note

## Electrical System

- 4220lm (45W)
- Power Input: Universal (120-277V)
- Operating Temperature: -13°F~112°F
- Surge Protection: 4KV
- Power Factor Greater than 0.9
- Remote Emergency Pack: Bodine BSL20LV

## LED Technology

- 2700K, 3000K, 3500K, 4000K, 5000K
- 85 CRI
- Beam Angle: 25°, 40°, 60°, 100°
- Rated Life > 60,000 Hours (L70)

## Advanced Dimming

(Proprietary VX Driver is incorporated to all dimming options for video flicker-free lighting)

- **Standard 0-10V** dims to 10%
- **DMX:** high resolution dims to 0.1% (Supports ANSI E1.20 RDM protocol)
- **Superior 0-10V:** dims to 1%
- **LTE: Hi-Lume 1% 2-wire LED Driver (120V forward phase only)**
- **LDE1: Hi-Lume 1% EcoSystem LED Driver with Soft-on, Fade-to-Black (UNV only)**

## Housing

- Diameter: 8.26" (210mm)
- Height: 9.25" (235mm)
- Material: Steel, Aluminum
- Weight: 11.02 lbs

## Mounting

- Surface Mount
- Stem 2ft, 4ft; 45° Swivel Canopy Included
- Adjustable Aircraft Cable 10ft
- Wall Mount
- Yoke Mount

## Warranty

- 5 year limited warranty

## Listing

- ETL Damp Location Listed
- CE



# Signum 8 - Standard



## How To Specify:

**Ordering Example: SS8-45-358-UNV-SPV-40-BLK-AD10**

**4-5 weeks lead time on over 75% of specifications.**

Model	Wattage	CCT / CRI	Voltage	Dimming
<b>SS8</b>			<b>UNV</b>	
SS8 Signum 8	<b>45</b> 45W	<b>278</b> 2700K / CRI85 <b>308</b> 3000K / CRI85 <b>358</b> 3500K / CRI85 <b>408</b> 4000K / CRI85 <b>508</b> 5000K / CRI85	<b>UNV</b> 120-277V	<b>STV</b> STV Standard 0-10V dims to 10% <b>SPV</b> Superior 0-10V dims to 1% <b>DMX</b> DMX dims to 0.1% (XLR Sockets) <b>DMX(RJ45)</b> DMX dims to 0.1% (RJ45 Sockets) <b>LTE</b> Hi-Lume 1% 2-wire LED Driver (120V forward phase only) <b>LDE1</b> Hi-Lume 1% EcoSystem LED Driver with Soft-on, Fade-to-Black (UNV only)

Beam Angle	Finish	Mounting	Accessories
<b>25</b> 25°	<b>BLK</b> Black	<b>SUM</b> Surface Mount	<b>SPD<sup>1</sup></b> Surge Protector
<b>40</b> 40°	<b>WHT</b> White	<b>ST2</b> Stem 2ft	<b>EMP</b> Remote Emergency Pack
<b>60</b> 60°		<b>ST4</b> Stem 4ft	
<b>WD</b> 100°		<b>AD10</b> Adjustable Aircraft Cable 10ft <b>WLM</b> Wall Mount <b>YKM</b> Yoke Mount	

<sup>1</sup> Surge protector for up to 10KV. Applicable for unstable mains or facilities using high power machineries

# Signum 8 - Standard

## Delivered Lumens\*

Wattage		SS8-45
CCT	Beam Angle: 25°	
5000K	4220 lm	
4000K	3770 lm	
3500K	3490 lm	
3000K	3350 lm	
2700K	3230 lm	

\*Tolerance±8%

## Current Consumption

Wattage		120V	277V
45W	0.47A	0.20A	

## Dimensions

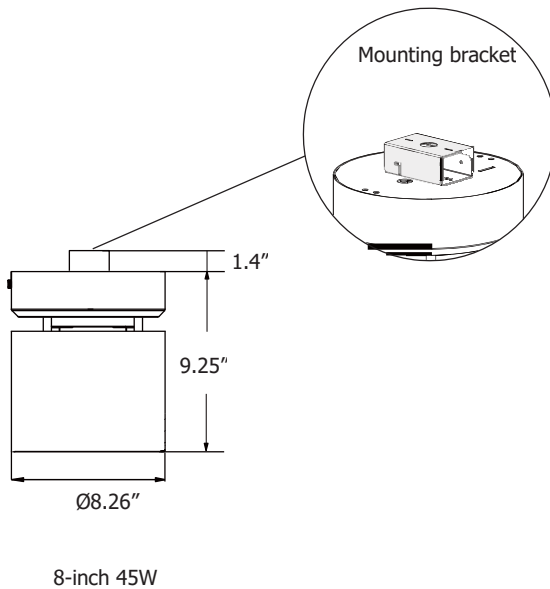

## Mounting Options

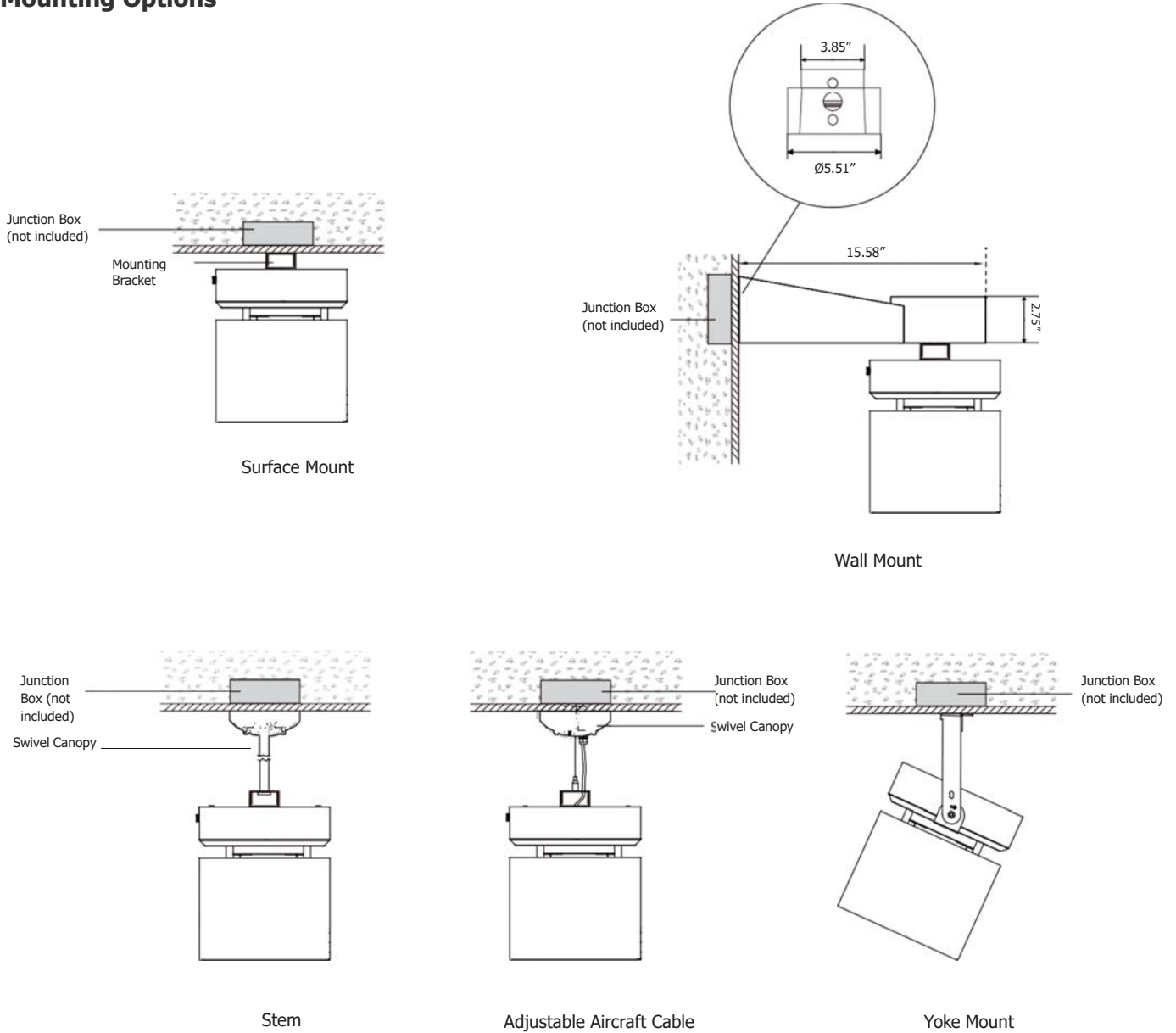

## DMX Requirements\*

The Signum 8 LED fixture with DMX is a ONE CHANNEL DMX unit.

**When placing order, please indicate DMX address.** (The DMX address will be listed on the back of the fixture.) The LED fixture provide RJ45 Socket or XLR socket to connect. (DMX cable NOT included.)

The final fixture should be terminated by the use of DMX Terminator (by others).

RJ45 Sockets

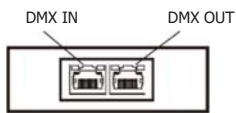

XLR Sockets

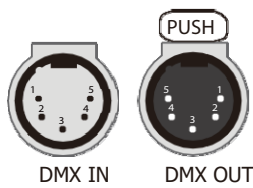

CONNECTION	RJ45 (CAT5e)	5-PIN XLR
Common	WHITE/BROWN(PIN7) & BROWN(PIN 8)	PIN 1
Signal -	ORANGE(PIN 2)	PIN 2
Signal +	WHITE/ORANGE(PIN 1)	PIN 3
Spare	-	PIN 4
Spare	-	PIN 5

DMX Connector      Mounting Bracket

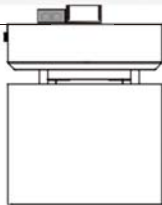

Surface Mount

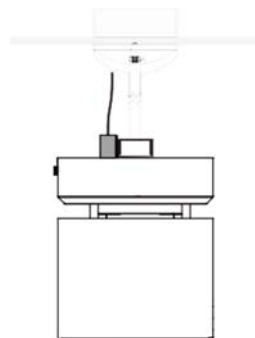

Stem

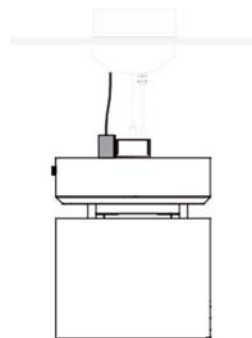

Adjustable Aircraft Cable

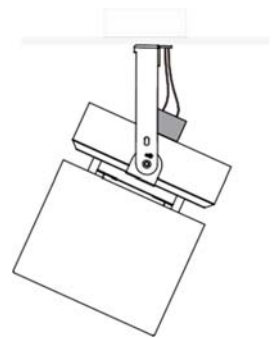

Yoke Mount

## Compatible LTE Dimmer List

**LUTRON PART NO.**

RRD-6NA-	RRT-G5NEW-	RRT-GH	HQRD-10ND-	HQRT-GH	HQRD-HN	PD-10NXD-
RRD-6ND	RRT-G25LW-	HQRD-6NA-	MRF2-6ND-120-	HQRT-G25LW-	GT-250M-	PD-5NE-
RRD-10ND-	RRD-HN	HQRD-6ND-	MRF2S-6ND-120-	HQRT-G5NEW-	GTJ-250M-	

# Signum 8 - Standard



## Remote Emergency Pack

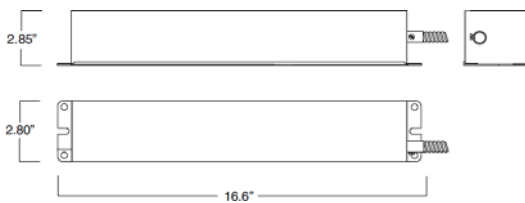

## Emergency Pack Lumen Output Table

CCT	2700K	3000K	4000K	5000K
Lumen	1640 lm	1760 lm	1890 lm	1950 lm

Mounting with standard ceiling recessed Junction BOX

