

# REIZEN – W+RGB Indoor

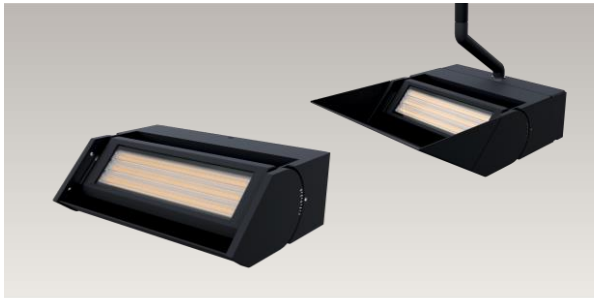

The REIZEN is an indirect asymmetric luminaire available in sconce or pendant forms, available with our Colorflip™ W+RGB technology. 50% of the 150W Light Engine is true 3000K and 50% is RGB. This unique approach to RGBW color changing brings a multifaceted option to a variety of architectural high ceiling spaces such as commercial, education, hospitality, municipalities, retail, and sports-recreation areas.



Quantity		Type	
Project		Note	

## Electrical System

- 150W Light Engine / 3000K=75W, RGB=75W
- Power Input: Universal (120-277V)
- Operating Temperature: -40°F~113°F
- Surge Protection: 4 KV
- Power Factor Greater than 0.9

## LED Technology

- White CCT: 3000K
- 85 CRI, 5000K / 75 CRI
- Beam Angle: Asymmetric
- Rated Life > 60,000 Hours (L70)

## Advanced Dimming

(Proprietary VX Driver is incorporated to all dimming options for video flicker-free lighting)

- DMX: high resolution dims to 0.1%  
(Supports ANSI E1.20 RDM protocol)

## Housing

- Dimensions & Weight:
- Standard: 13.05" x 9.84" x 4.33" (19.8 lb)
- With Visor: 13.05" x 14.77" x 4.33" (22.9 lb)
- Material: Stainless Steel Housing, Aluminum Heat Sink

## Mounting

- Wall Mount
- Stem Mount

## Warranty

- 5-year limited warranty

## Listing

- ETL Damp Location Listed
- FCC
- CE



# REIZEN – W+RGB Indoor



## How to Specify:

Ordering Example: REIZEN-308C-UNV-DMXR-ASY-WHT-WLM-GSV

4-5 weeks lead time on over 75% of specifications.

Model	Light Source	Voltage	Dimming
<b>RI</b>			
REIZEN	<b>308C</b> 150W Light Engine 11,265 Combined Delivered Lumens 3000K / CRI 85 + RGB	<b>UNV</b> 120-277V	<b>DMXR</b> DMX dims to 0.1% (RJ45 Sockets)

Beam Angle	Finish	Mounting	Accessories
<b>ASY</b> Asymmetric	<b>BLK</b> Black <b>WHT</b> White	<b>WLM</b> Wall Mount <b>ST4</b> Stem 4ft <b>ST8<sup>1</sup></b> Stem 8 ft	<b>GSV<sup>1</sup></b> Glare Shield Visor
		<sup>1</sup> Includes two 4ft stem connected by an adapter.	<sup>1</sup> Please factor in change in lumen output of -10%.

## Delivered Lumens\*

Light Source \ CCT	308C 150W Light Engine Beam Angle: Asymmetric	
	<b>R</b>	25 W
<b>G</b>	25 W	2,750 lm
<b>B</b>	25 W	205 lm
<b>W</b>	75 W	8,000 lm

\*Tolerance±8%

## Current Consumption

Light Source	Wattage	120V	277V
308C	150W	1.38A	0.60A

# REIZEN – W+RGB Indoor

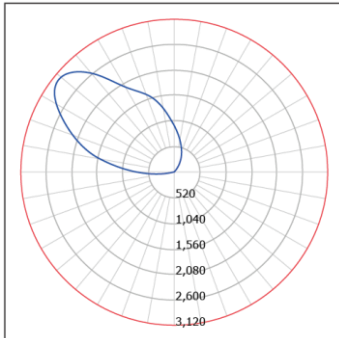

## **308C**

### **Descriptive Information**

Total delivered lumens: 11,265 Lumens

Input watts at 120V: 150 W

Source: LED

CCT/CRI: 4000K/85CRI

# REIZEN – W+RGB Indoor



## Dimensions

308C / Wall Mount

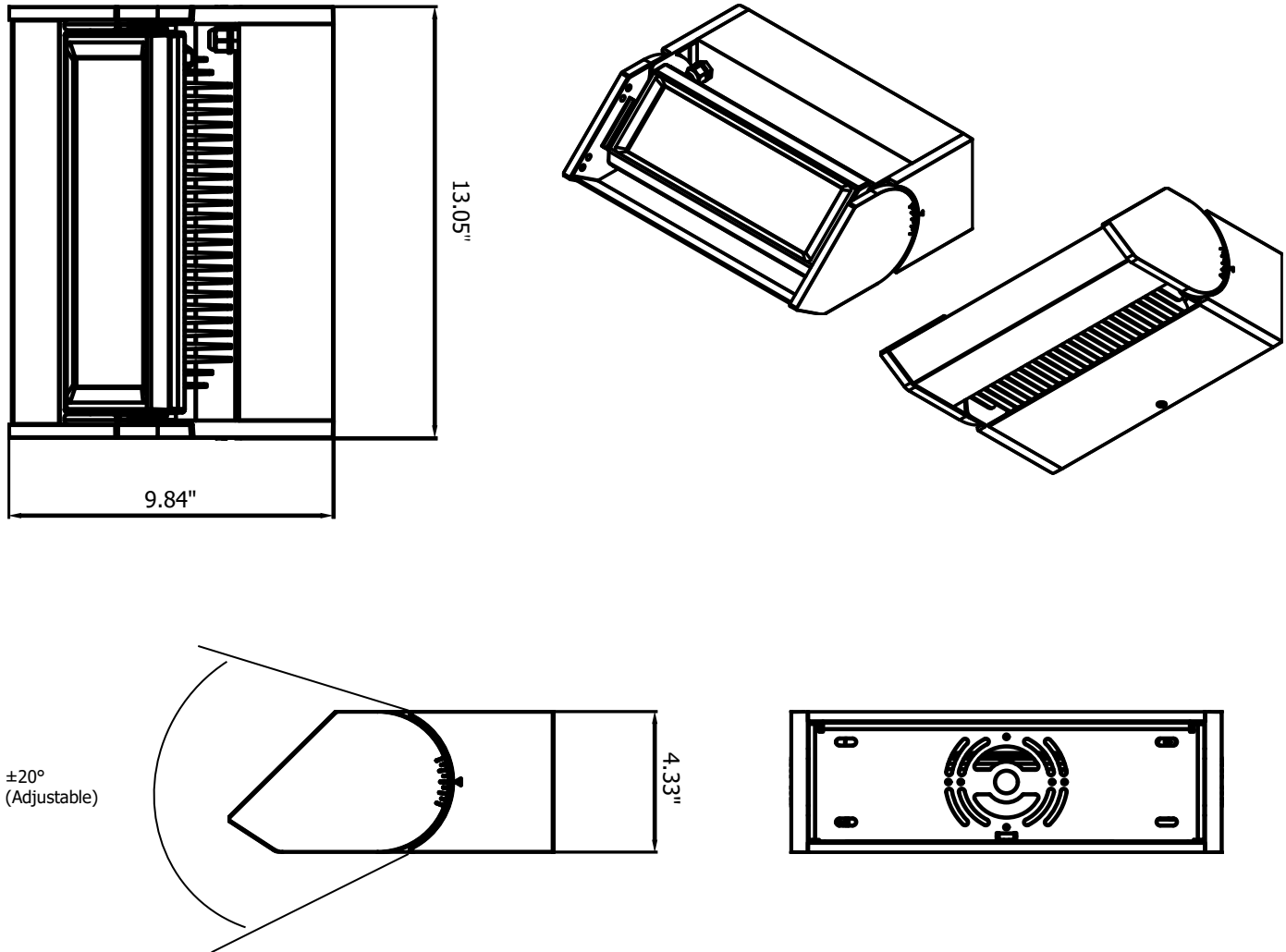

# REIZEN – W+RGB Indoor



## Dimensions

308C / Stem Mount

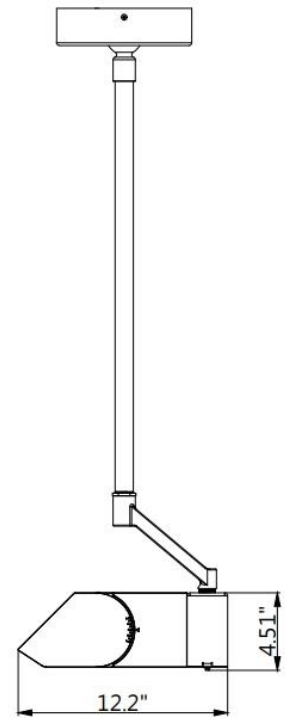
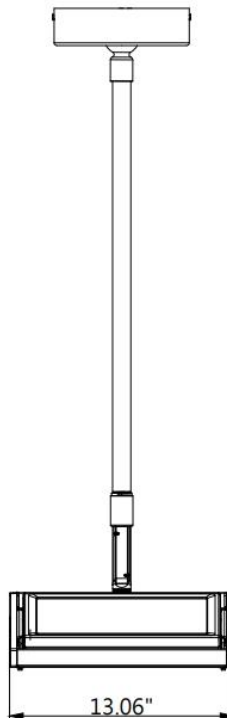
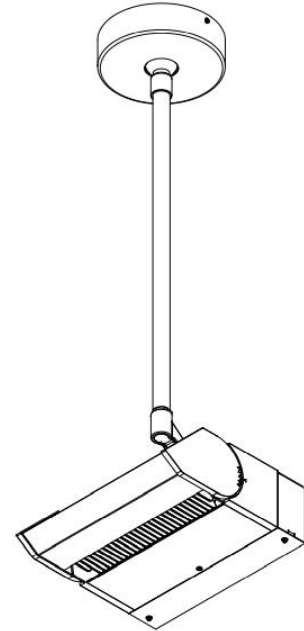
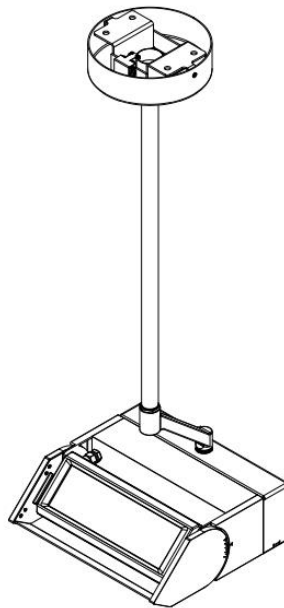
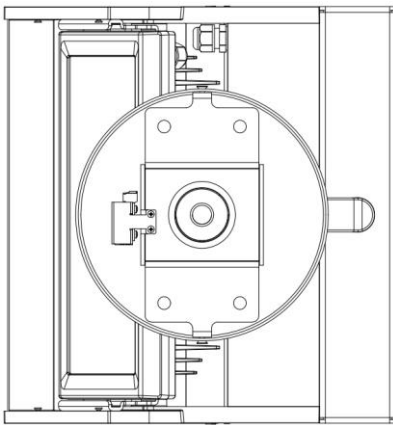

# REIZEN – W+RGB Indoor



## Accessory

Glare Shield Visor

**308C**

