

ADVANCED HIGH CEILING  
**Edge 4 - Standard**



Architectural & Powerful 4 Inch Luminaire  
 4-inch aperture square pendant with a lumen package range of 1300 - 4000 lumens. Compatible with all 0-10v dimming controls and DMX dimming with ANSI E1.20 RDM Protocol. This aesthetic luminaire is designed to elevate and illuminate beautiful spaces.

Quantity		Type	
Project		Note	

**Electrical System**

- 1300lm (15W)
- 2200lm (25W)
- 3150lm (35W)
- 4000lm (45W)
- Power Input: Universal (120-277V)
- Operating Temperature: 14°F~104°F
- Surge Protection: 2.5KV
- Power Factor Greater than 0.9

**LED Technology**

- 2700K, 3000K, 3500K, 4000K
- 85 CRI, 93 CRI
- Beam Angle: 35°, 45°, 60°, WD
- Rated Life > 60,000 Hours (L70)

**Advanced Dimming**

(Proprietary VX Driver is incorporated to all dimming options for video flicker-free lighting)

- Standard 0-10V: dims to 10%
- Superior 0-10V: dims to 1%
- DMX: high resolution dims to 0.1% (Supports ANSI E1.20 RDM protocol)
- LTE: Hi-Lume 1% 2-wire LED Driver (120V forward phase only)
- LDE1: Hi-Lume 1% EcoSystem LED Driver with Soft-on, Fade-to-Black (UNV only)

**Housing**

- Diameter: 4" (102mm)
- Height: 9.5" (240mm)
- Material: Aluminum
- Weight: 8 lbs

**Mounting**

- Power Line Mount 2ft, 4ft, 6ft, 8ft, 10ft with High Lumen Power Suspension
- Stem 2ft or 4ft
- Cord Mount 10ft
- Surface Mount
- Wall Mount

**Warranty**

- 5 year limited warranty

**Listing**

- ETL Listed



ADVANCED HIGH CEILING  
**Edge 4 - Standard**



How To Specify:

Ordering Example: ED4-15-408-UNV-SPV-25-BLK-BLK-PL2

4-5 weeks lead time on over 75% of specifications.

Model	Wattage	CCT / CRI	Voltage	Dimming
<input type="text" value="ED4"/>	<input type="text"/>	<input type="text"/>	<input type="text" value="UNV"/>	<input type="text"/>
ED4	15 15W	278 2700K / CRI85	UNV 120-277V	STV Standard 0-10V dims to 10%
Edge 4	25 25W	308 3000K / CRI85		SPV Superior 0-10V dims to 1%
	35 35W	358 3500K / CRI85		DMX(RJ45) <sup>1</sup> DMX dims to 0.1% (RJ45 Sockets)
	45 45W	408 4000K / CRI85		LTE Hi-Lume 1% 2-wire LED Driver (120V forward phase only)
		279 2700K / CRI93		LDE1 Hi-Lume 1% EcoSystem LED Driver with Soft-on, Fade-to-Black (UNV only)
		309 3000K / CRI93		
		359 3500K / CRI93		

<sup>1</sup> Option is only compatible with remote power canopy.

Beam Angle	Finish	Reflector Finish	Mounting	Option
<input type="text"/>	<input type="text"/>	<input type="text"/>	<input type="text"/>	<input type="text"/>
35 35°	BLK Black	BLK Black	PL2 Power Line Mount 2ft	RM Remote Power
45 45°	WHT White	GLD Gold	PL4 Power Line Mount 4ft	
60 60°			PL6 Power Line Mount 6ft	
WD* WIDE			PL8 Power Line Mount 8ft	
			PL10 Power Line Mount 10ft	
			CM10 Cord Mount 10ft	
			ST2 Stem 2ft	
			ST4 Stem 4ft	
			SUM* Surface Mount	

\*Please factor in change in lumen output with diffuser -20%.

\*All finishes come with standard black reflector.

\*Option is not compatible with remote power.

\*Remote Power comes with a Shallow canopy.

ADVANCED HIGH CEILING  
**Edge 4 - Standard**



**Delivered Lumens\***

Wattage	15W	25W	35W	45W
CCT	Beam Angle: 35°			
4000K	1330 lm	2160 lm	3150 lm	4000 lm
3500K	1300 lm	2100 lm	3060 lm	3820 lm
3000K	1260 lm	2030 lm	2910 lm	3700 lm
2700K	1200 lm	1950 lm	2850 lm	3550 lm

\*Tolerance ± 8%

**DMX Requirements\***

The Edge 4 LED fixture with DMX is a ONE CHANNEL DMX unit.  
 When placing order, please indicate DMX address. (The DMX address will be listed on the back of the fixture.)  
 The LED fixture provide RJ45 Socket socket to connect. (DMX cable NOT included.)  
 The final fixture should be terminated by the use of DMX Terminator (by others).

CONNECTION	RJ45 (CAT5e)
Common	WHITE/BROWN(PIN7) & BROWN(PIN 8)
Signal -	ORANGE(PIN 2)
Signal +	WHITE/ORANGE(PIN 1)
Spare	-
Spare	-

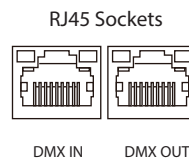

**Dimensions**

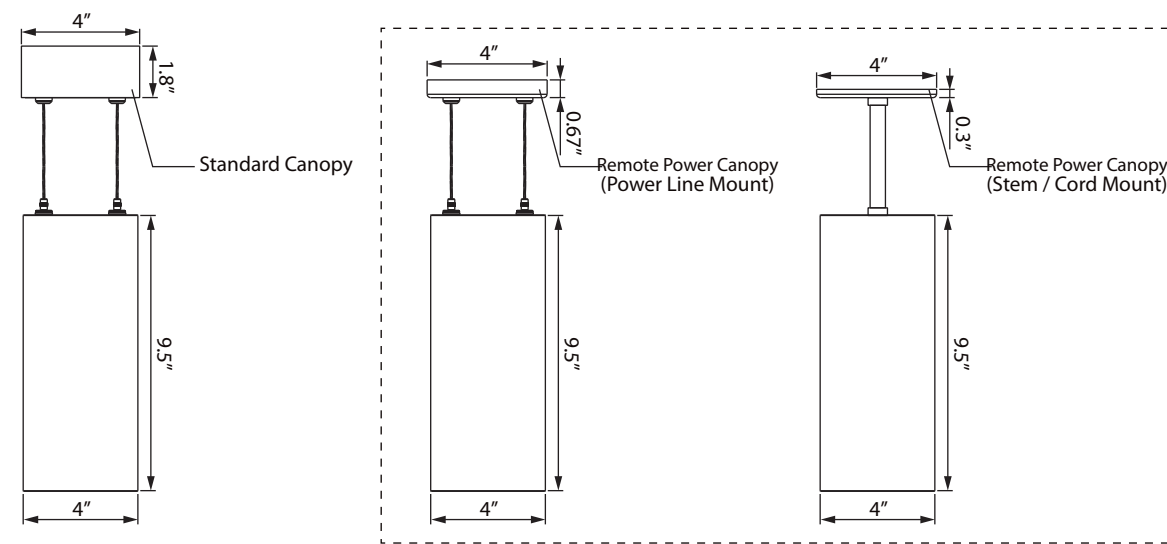

STV / SPV / TRC

STV / SPV / DMX / TRC / ECO  
 (Remoted length can be 50ft max.)

ADVANCED HIGH CEILING  
**Edge 4 - Standard**



Mounting Options

Standard Driver-In Canopy Mounting Options

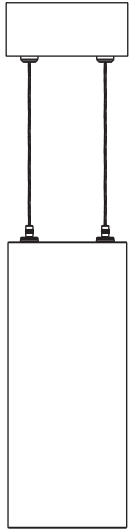

Power Line

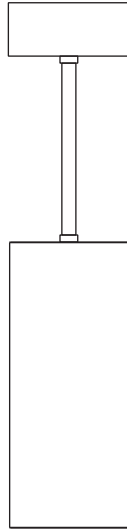

Stem

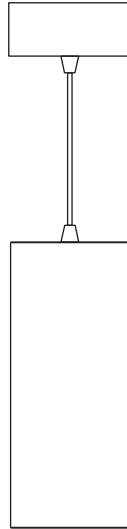

Cord Mount



Surface Mount  
(Only standard canopy)

Remote Driver Canopy Mounting Options

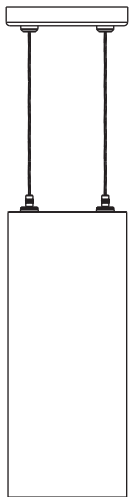

Power Line

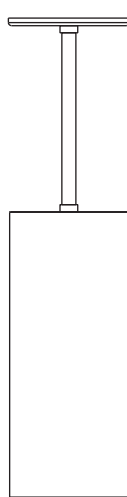

Stem

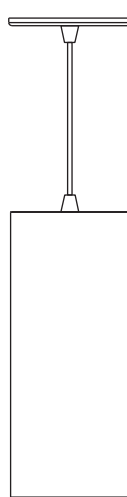

Cord Mount

ADVANCED HIGH CEILING  
Edge 4 - Standard



Remote Power Box

