

Dext 2.0 - Outdoor/Natatorium



High Lumen, High Bay Luminaire with 16,500 - 34,800 lumen output, perfectly suited for 400/500W Metal Halide replacements.

Quantity	Type
Project	Note

Electrical System

- Downlight
- 17400 lm (150W)
- 23200 lm (200W)
- 34800 lm (280W)
- Power Input: Universal (120-277V)
- Operating Temperature: -40°F~112°F
- Surge Protection: 4KV

LED Technology

- 3000K, 4000K, 5000K
- 80 CRI
- Beam Angle: 50°, 100°
- Rated Life > 60,000 Hours (L70)

Advanced Dimming

(Proprietary VX Driver is incorporated to all dimming options for video flicker-free lighting)

- Standard 0-10V: dims to 10%

Housing

- Diameter: Ø14.5" (368mm)
- Height: 10.25" (260mm)
- Material: High Pressure Die-Cast Aluminum, PC lens
- Weight: 17.64lbs

Mounting

- Stem 2ft or 4ft; 45° Swivel Canopy Included
- Adjustable Aircraft Cable 10ft
- Bracket

Warranty

- 5 years limited warranty

Listing

- ETL Wet Location Listed
- IP65



Not all Dext 2.0 Series are DLC qualified. For all qualified products. Please visit: www.designlights.org/qpl

Dext 2.0 - Outdoor/Natatorium



How To Specify:

Ordering Example: DS2-150-508-UNV-STV-100-WHT-ST2-WG

Model	Wattage	CCT / CRI	Voltage	Dimming
DS2			UNV	STV
DS2	150 150W	308 3000K / CRI 80	UNV 120-277V	NOD Non-Dimming STV Standard 0-10V dims to 10%
Dext 2.0 Series	200 200W	408 4000K / CRI 80		
	280 280W	508 5000K / CRI 80		

Beam Angle	Finish	Mounting	Accessories	Rating
50 50° 100 100° *Beam angle options are only available for Downlight. *Uplight beam angle fixed at 100°.	BLK Black WHT White	ST2 Stem 2ft ST4 Stem 4ft AD10 Adjustable Cable 10ft BRK Bracket	SPD ¹ Surge Protector WG ² Wire Guard	OUT ¹ Outdoor Rating NAT ² Natatorium Rating

Delivered Lumens*

Downlight

Wattage \ CCT	Beam Angle: 50°		
	150W	200W	280W
5000K	17,400 lm	23,200 lm	34,800 lm
4000K	16,950 lm	22,600 lm	33,900 lm
3000K	16,500 lm	22,000 lm	33,000 lm

*Tolerance±8%

DesignLights Consortium™ Qualified Luminaires:
 DLC QPL Model Number : DS2-220-507, DS2-220-407
 Not all product variations listed on this page are DLC qualified.
 To ensure that a specific model is qualified, visit
www.designlights.org/search.

Current Consumption

Wattage \ Volt	120V	277V
150W	1.52A	0.66A
200W	2.03A	0.88A
280W	3.05A	1.32A

Dext 2.0 - Outdoor/Natatorium



Dimensions

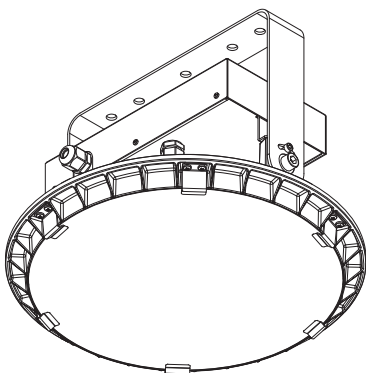
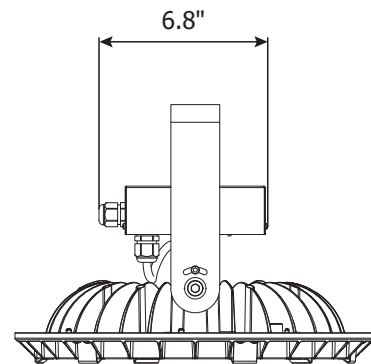
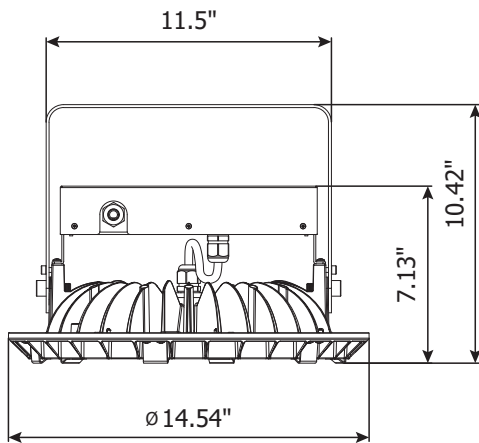
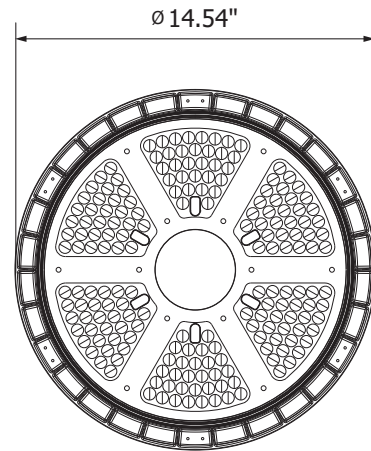
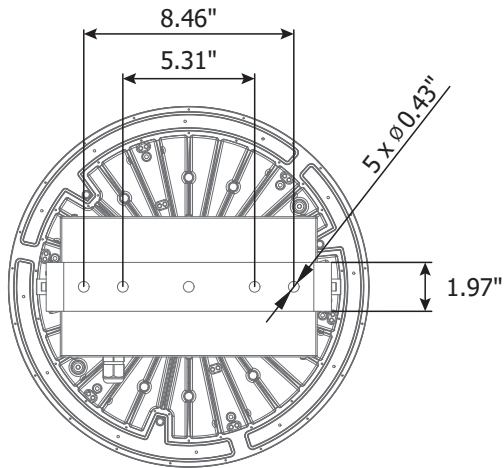

Dext 2.0 -



Mounting Options

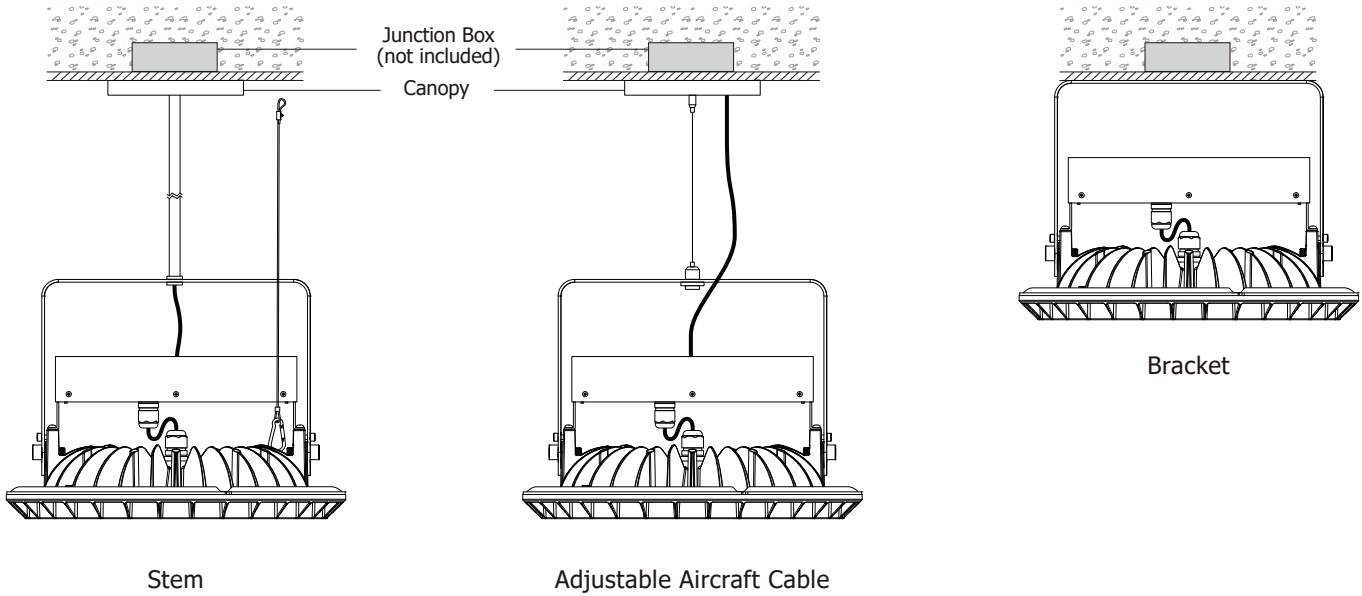

Accessory

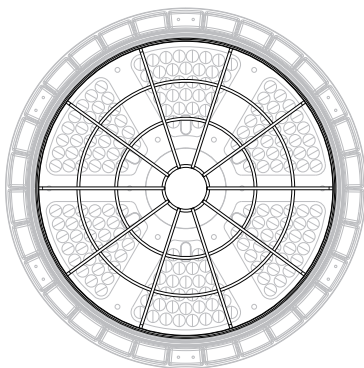

Wire Guard