

ADVANCED HIGH CEILING Dext 2.0 Mini 12 - Adjustable Cable



IMPORTANT SAFETY INFORMATION. READ AND FOLLOW ALL SAFETY INSTRUCTIONS

IMPORTANT SAFETY INFORMATION. READ AND FOLLOW ALL SAFETY INSTRUCTIONS. Before wiring to power supply and during servicing or relamping, turn off power at fuse or circuit breaker. All servicing or relamping must be performed by qualified service personnel. Product must be grounded to avoid potential electric shock or other potential hazard. Product must be at locations and at heights and in a manner consistent with its intended use, and in compliance with Electrical Code and local codes.

SAVE THESE INSTRUCTIONS FOR FUTURE REFERENCE.

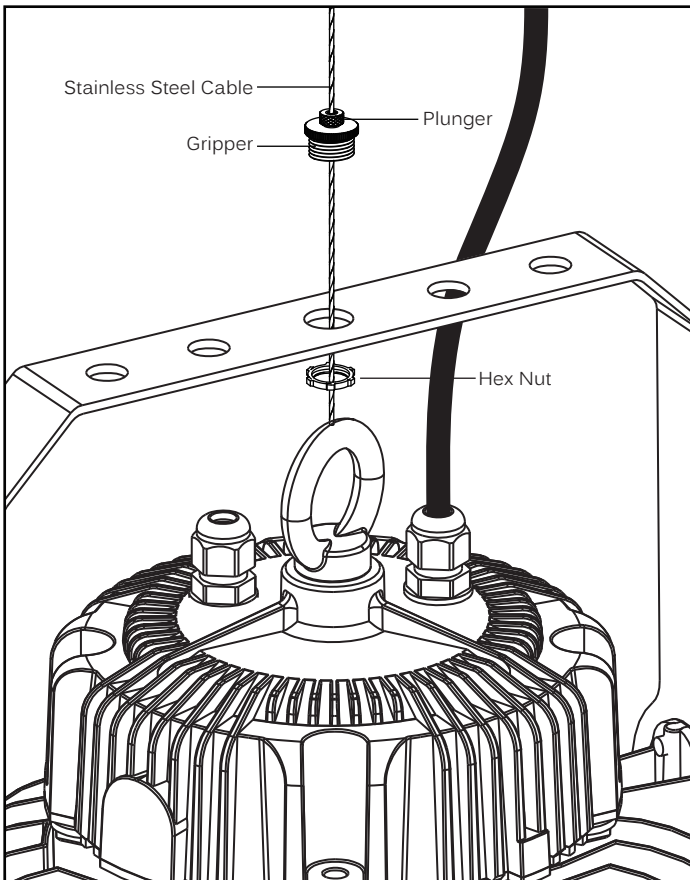

Step 1

Insert the cable through the gripper and plunger. To adjust the cable to desired length, press the plunger.

ADVANCED HIGH CEILING

Dext 2.0 Mini 12 - Adjustable Cable

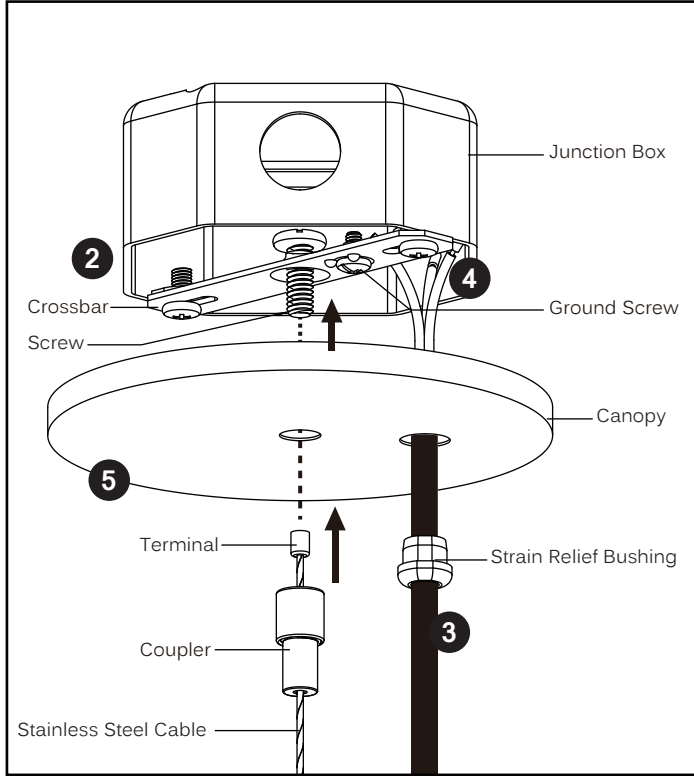

Step 2

Secure the crossbar to the 4" octagonal box (by others) designed to support the weight of the fixture.

Step 3

Lock the strain relief bushing to the power cord with allowance for wiring connections, and thread the power cord through the canopy wire hole.

Step 4

Connect the Green ground conductor to the ground screw on the crossbar, the line voltage to the Black conductor, and the neutral to the White conductor. For 0-10V dimming option, connect the two remaining conductors (Data+ to Purple conductor and Data- to Gray conductor).

* Make all connections with UL approved connectors.

Step 5

Thread the cable through the coupler with the terminal side on top. Slide the coupler up to the canopy and secure with the screw on crossbar.

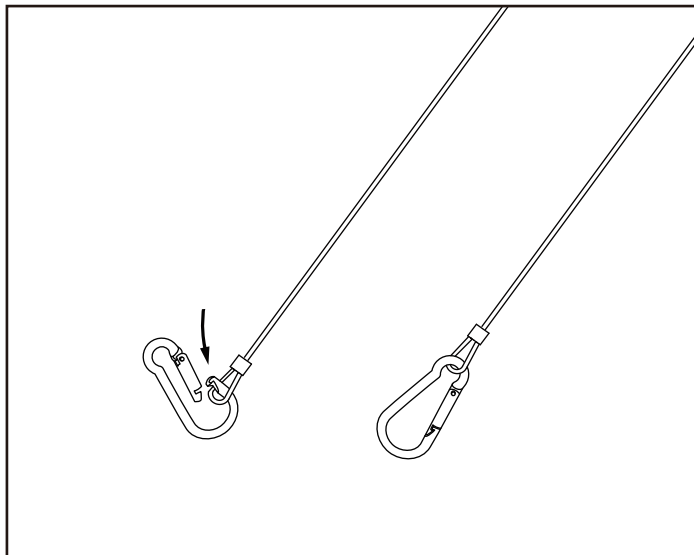

Step 6

Clasp the hook through the aircraft cable loophole created.

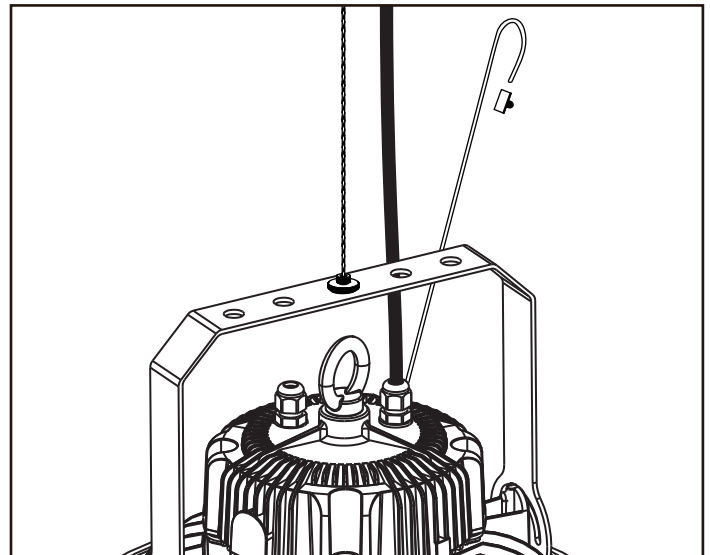

Step 7

Clasp the hook onto the allocated bolt on the fixture mount.

ADVANCED HIGH CEILING

Dext 2.0 Mini 12 - Adjustable Cable

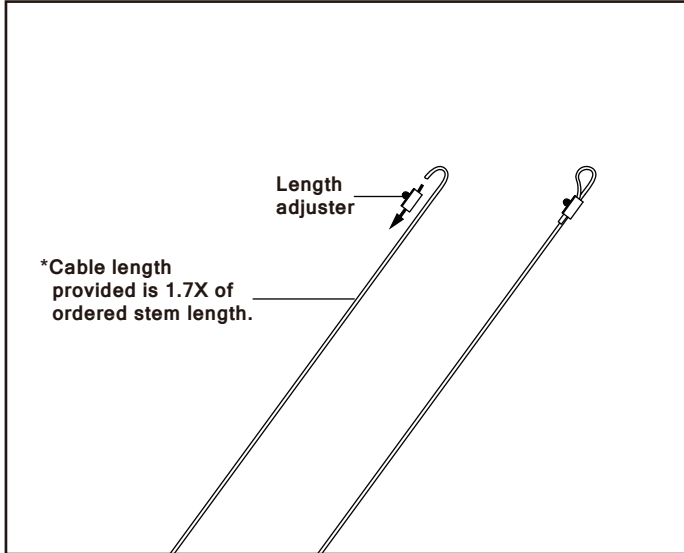

Step 8

Loop the aircraft cable through the mounting corners and tighten the clamp by adjusting the screw. Ensure that the height is adjusted before tightening the clamp.

Wiring Diagram

0-10V / Superior 0-10V

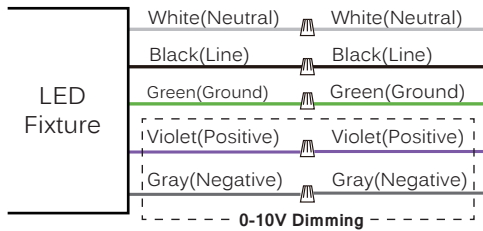

SPD

