

ADVANCED HIGH CEILING Dext 2.0 Mini 10 - Stem



IMPORTANT SAFETY INFORMATION. READ AND FOLLOW ALL SAFETY INSTRUCTIONS

IMPORTANT SAFETY INFORMATION. READ AND FOLLOW ALL SAFETY INSTRUCTIONS. Before wiring to power supply and during servicing or relamping, turn off power at fuse or circuit breaker. All servicing or relamping must be performed by qualified service personnel. Product must be grounded to avoid potential electric shock or other potential hazard. Product must be at locations and at heights and in a manner consistent with its intended use, and in compliance with Electrical Code and local codes.

SAVE THESE INSTRUCTIONS FOR FUTURE REFERENCE.

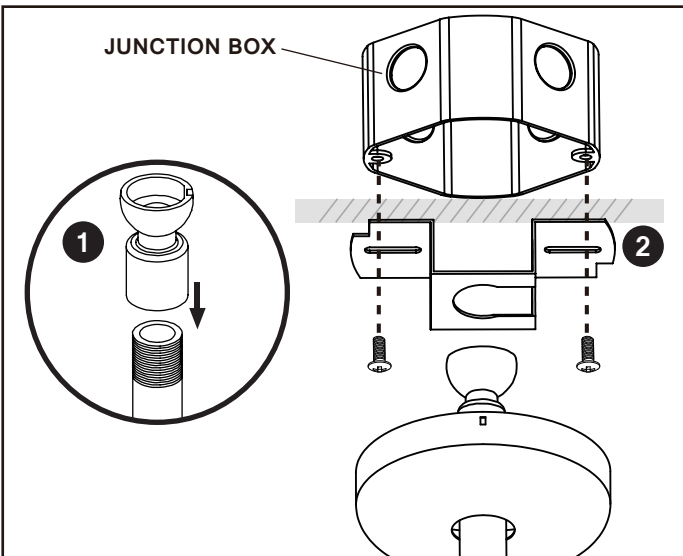

Step 1

Secure half ball with stem.

Step 2

Attach swivel crossbar to junction box (by others).

Step 3

Feed the safety cable and power cord through the stem and insert half ball joint into slot on swivel crossbar. Align the slot on ball joint with the tab on the swivel crossbar.

Step 4

Make electric connection in junction box. (See below)

Step 5

Install canopy cover by aligning the tabs on crossbar with slots in the cover.

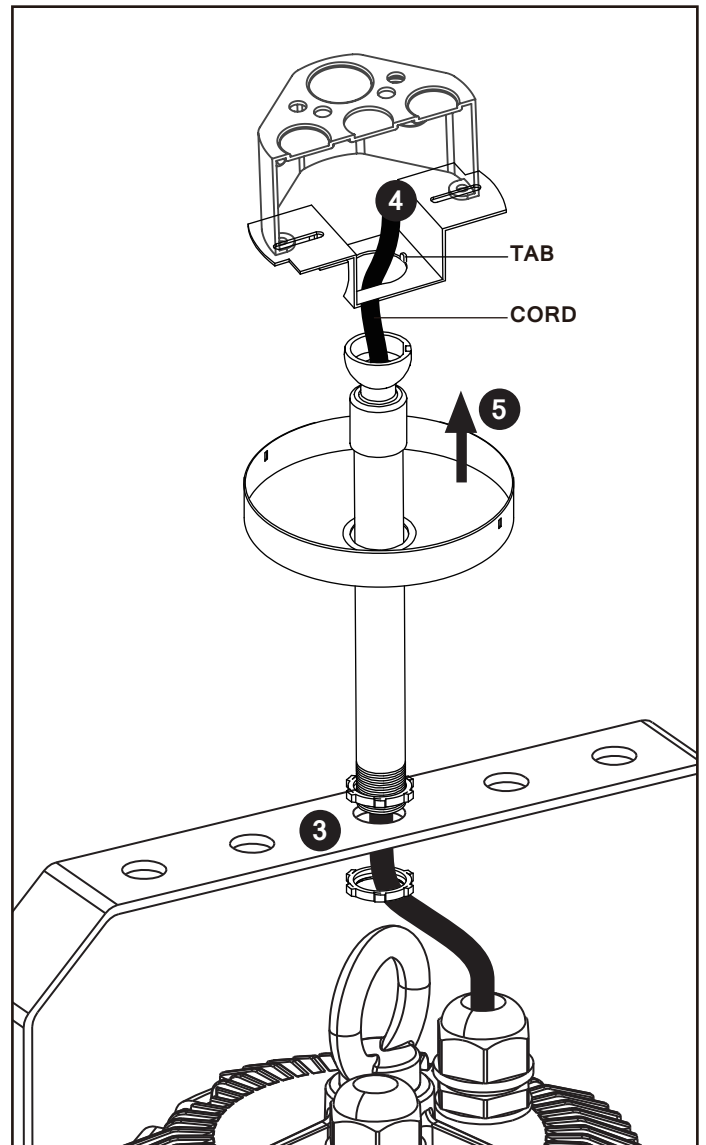

ADVANCED HIGH CEILING Dext 2.0 Mini 10 - Stem

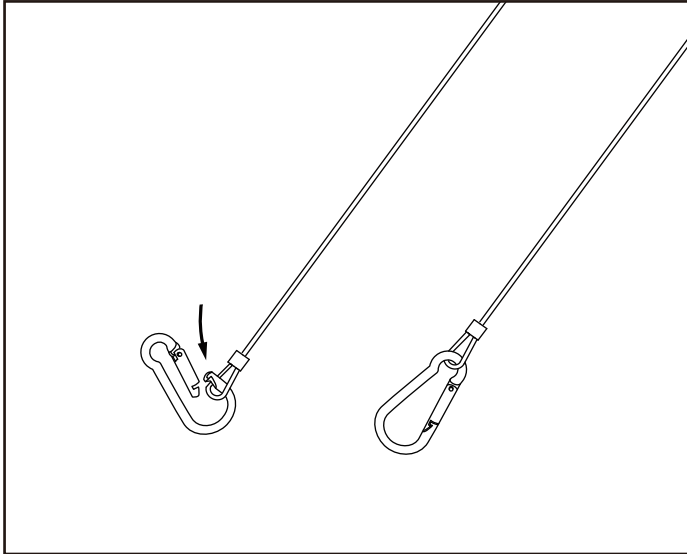

Step 6

Clasp the hook through the aircraft cable loophole created.

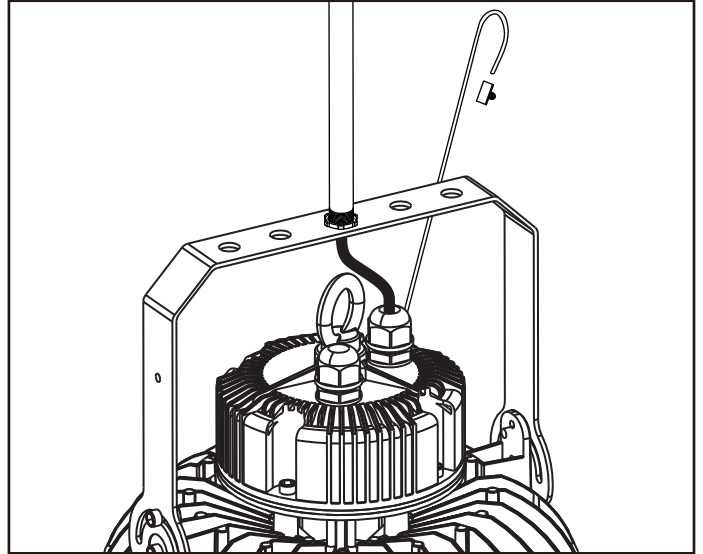

Step 7

Clasp the hook onto the allocated bolt on the fixture mount.

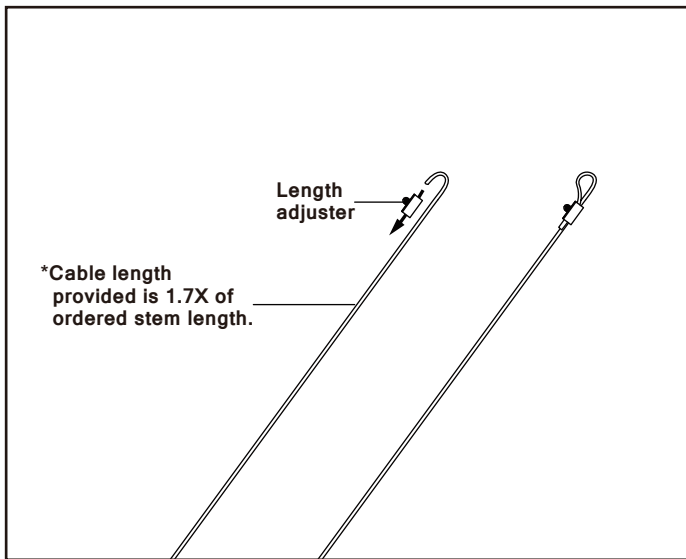

Step 8

Loop the aircraft cable through the mounting corners and tighten the clamp by adjusting the screw. Ensure that the height is adjusted before tightening the clamp.

ADVANCED HIGH CEILING Dext 2.0 Mini 10 - Stem



Wiring Diagram

0-10V / Superior 0-10V

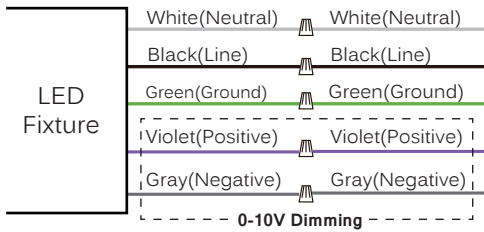

SPD

