

DUO 6 - (SPVS. SPVD)



IMPORTANT SAFETY INFORMATION. READ AND FOLLOW ALL SAFETY INSTRUCTIONS

IMPORTANT SAFETY INFORMATION. READ AND FOLLOW ALL SAFETY INSTRUCTIONS. Before wiring to power supply and during servicing or relamping, turn off power at fuse or circuit breaker. All servicing or relamping must be performed by qualified service personnel. Product must be grounded to avoid potential electric shock or other potential hazard. Product must be at locations and at heights and in a manner consistent with its intended use, and in compliance with Electrical Code and local codes.

SAVE THESE INSTRUCTIONS FOR FUTURE REFERENCE.

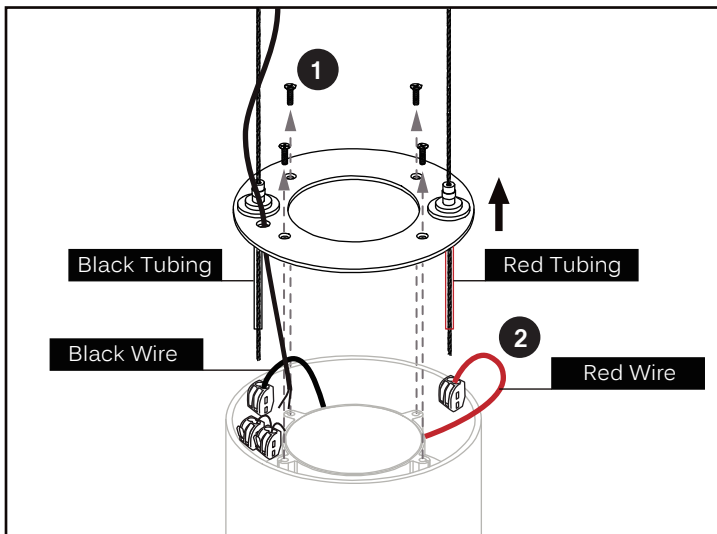

Step 1
Unscrew the ring plate on top of the fixture by removing the Phillips screws.

Step 2
Disconnect the insulated Black and Red wires from the WAGO Connector. Making sure to set aside all components.

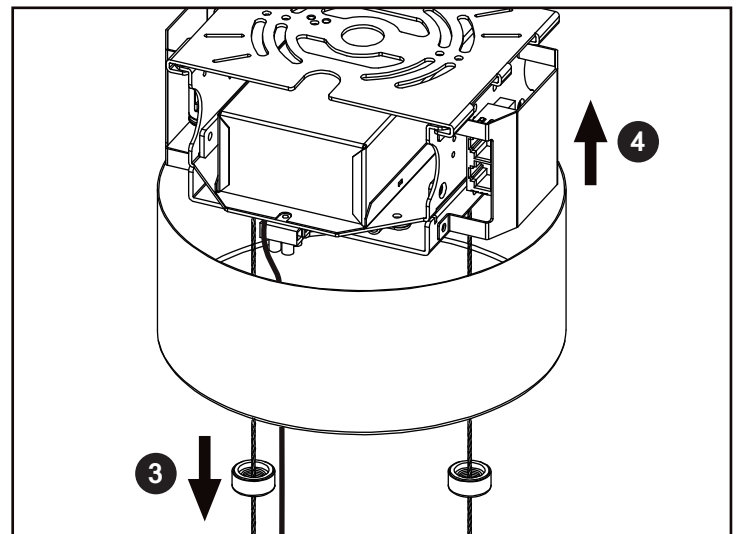

Step 3,4
Loosen the two bolts on the canopy, and remove the power module by sliding down the canopy housing.

DUO 6 - (SPVS. SPVD)

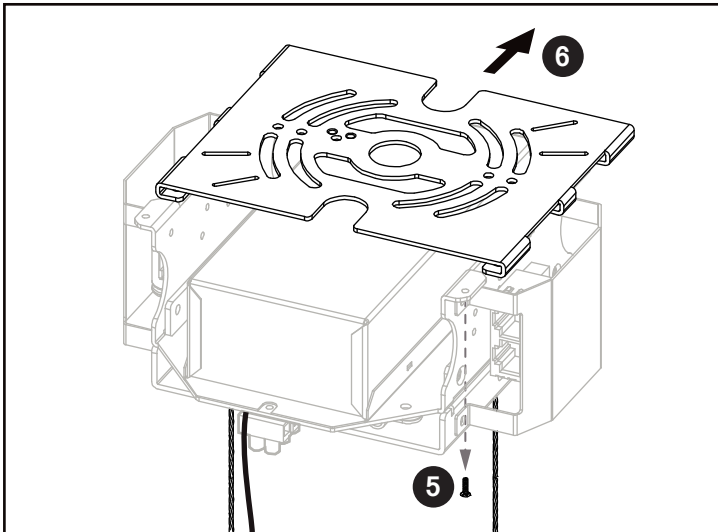

Step 5,6
Remove the two screws on opposite ends of the bracket to loosen the mounting plate and slide the mounting plate out.

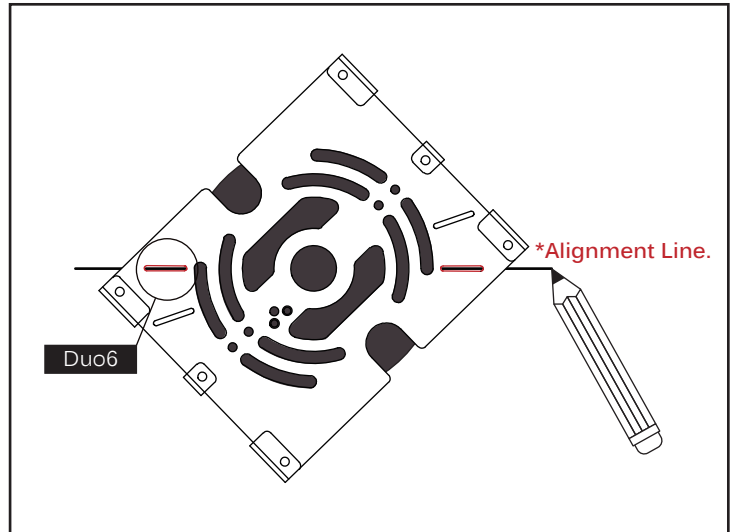

Step 7
Mark an alignment line on the ceiling and align it with the indicated markers on the mounting plate. The mounting plate will be slanted at an angle in relation to the horizontal line as shown in the diagram.

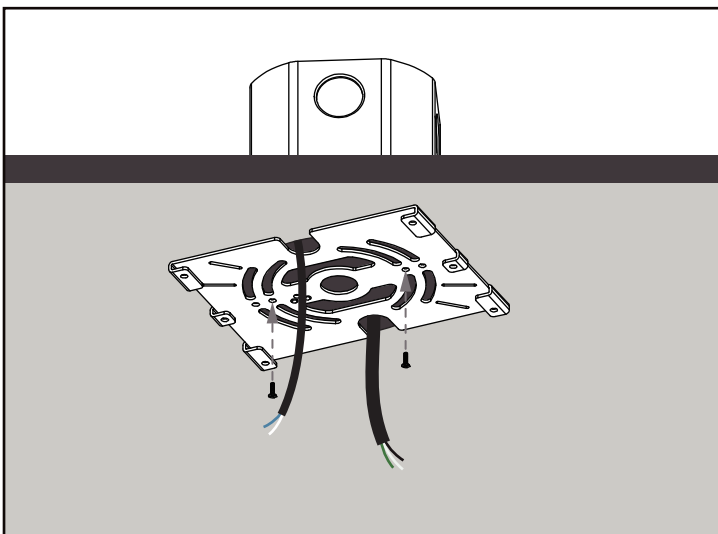

Step 8
Once aligned, screw the mounting plate into place with 2 – 3 screws on the available ports and thread through the wires from the junction box.

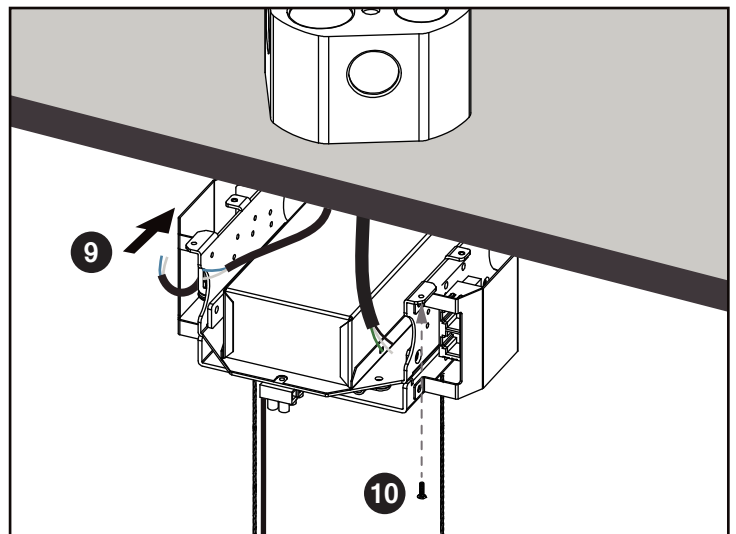

Step 9,10
Once the mounting plate is steady, slide the power module onto the mounting plate and fasten the two screws previously removed on opposite corners of the mounting plate.

Step 11
First connect the wires from the junction box onto the terminal block, next connect the dimming wires. Refer to the wiring diagram for a more detailed explanation.

DUO 6 - (SPVS. SPVD)

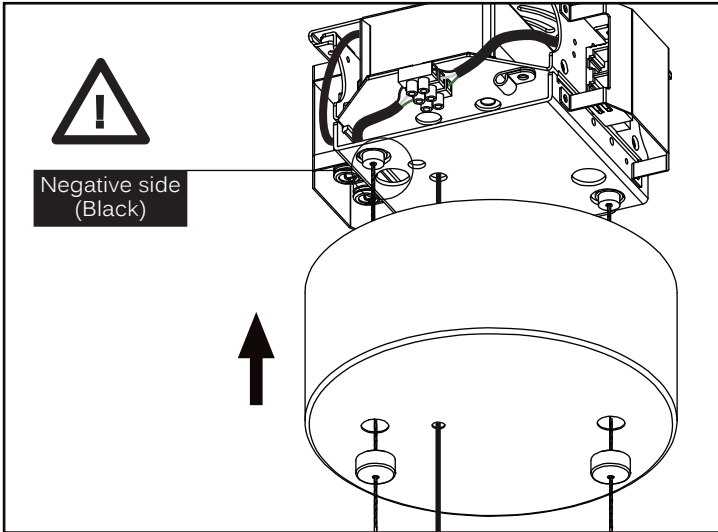

Step 12
Identify the negative side of the fixture (Marked by a black discoloration and a label sticker), Place the canopy around the power module and fasten the two bolts.

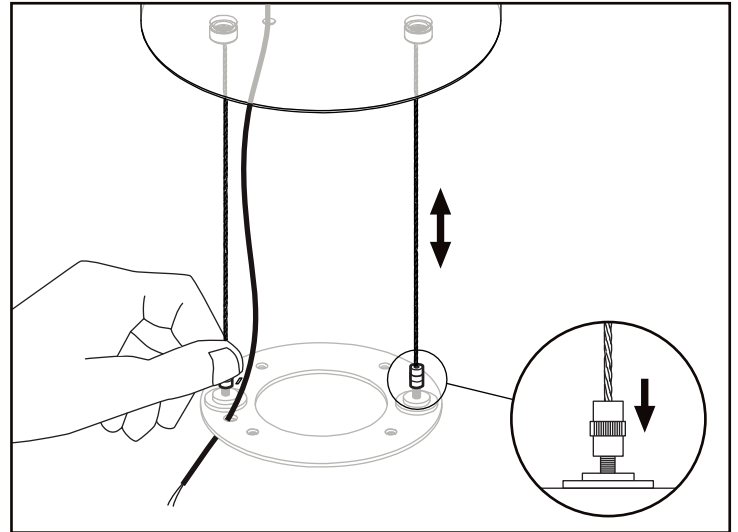

Step 13
To adjust the cable gripper, simply turn it clockwise by 2 – 3 rotations. Then push down to unclamp the wire, next adjust the dimming wires. Note: Adjusting the height without attaching the fixture is less strenuous.

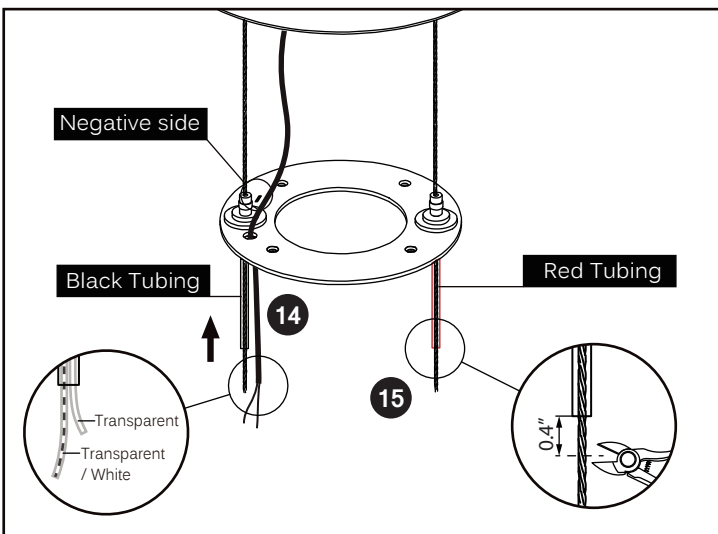

Step 14
Once adjusted to the right height, you might have some unnecessary cable length. Slip the Black Insulation tubing on the negative side wire and the Red insulation tubing on the other wire, ensuring end to end coverage.

Step 15
Then leave a 0.5-inch gap before cutting the extra wires. It is important to cut unnecessary wire length to prevent contact and short circuiting.

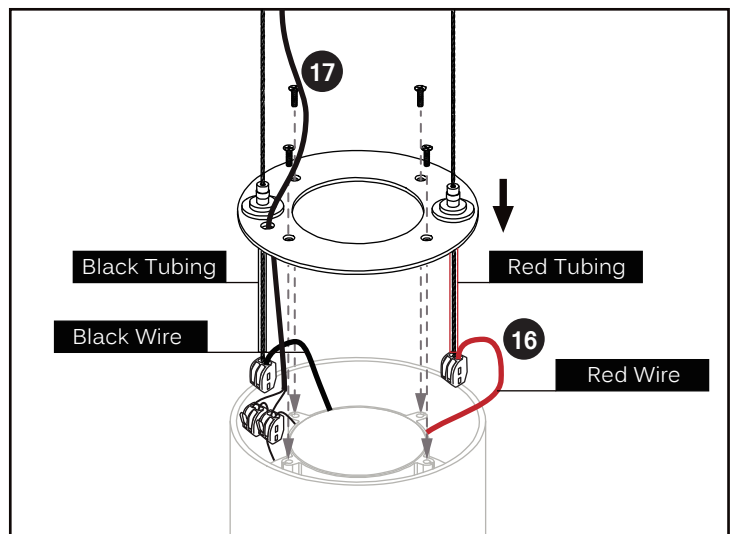

Step 16
Bring up the fixture and connect the black wire to the black tubing and the Red wire to the Red tubing, As well as the dimming WAGO connectors to the dimming wires available.

Step 17
Screw three Phillips screws on the ring plate.

DUO 6 - (SPVS. SPVD)

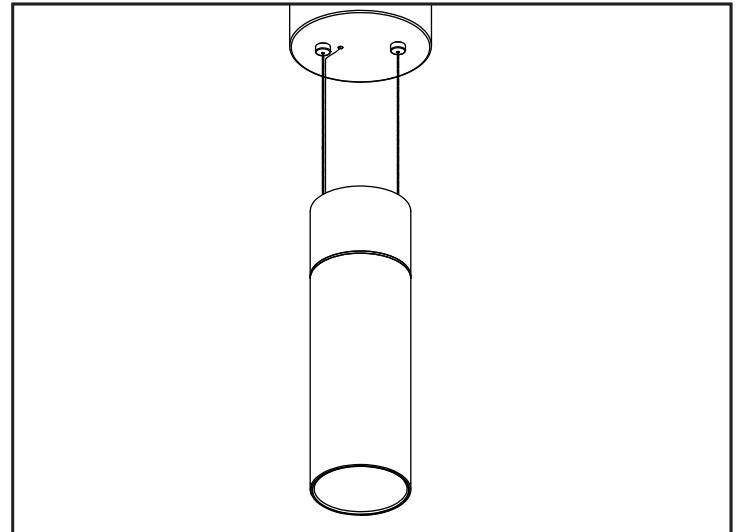
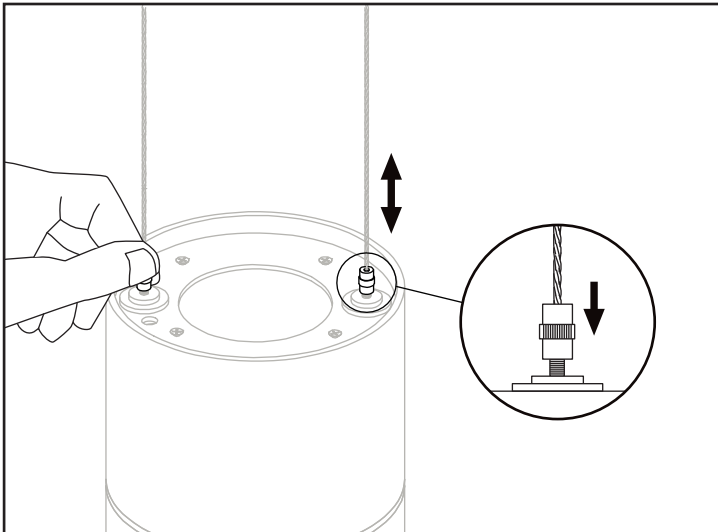

Step 18

To adjust the cable gripper, simply turn it clockwise by 2 – 3 rotations. Then push down to unclamp the wire. Note: You can also simply push the wire down to raise the fixture or push down the gripper to lower the fixture.

Step 19

Installation Complete.

DUO 6 - (SPVS. SPVD)



Wiring Diagram

SPVS

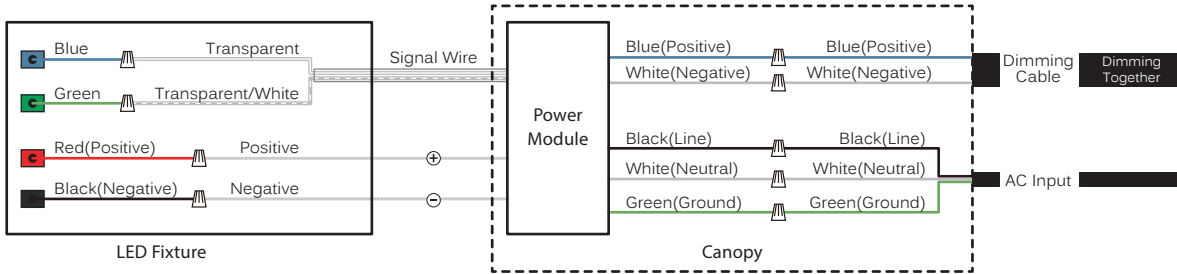

SPVD

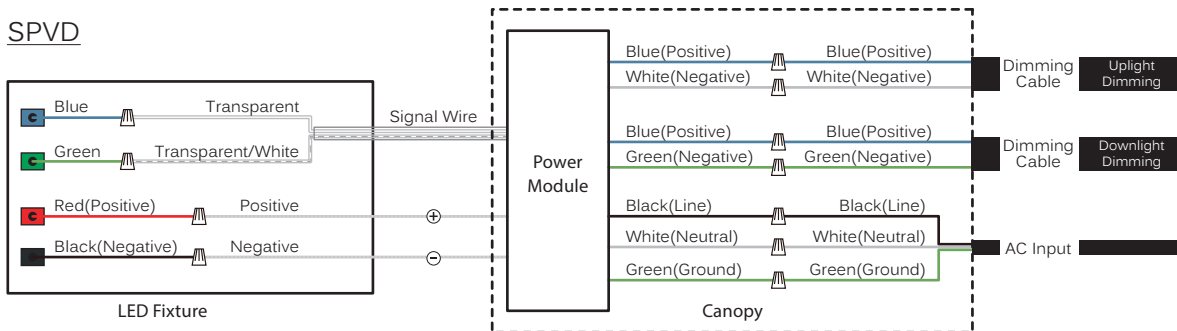

SPVS / Remote Power

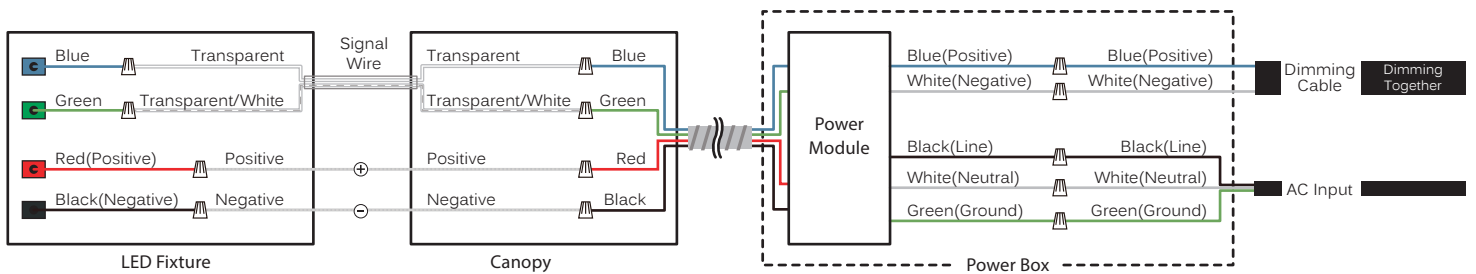

SPVD / Remote Power

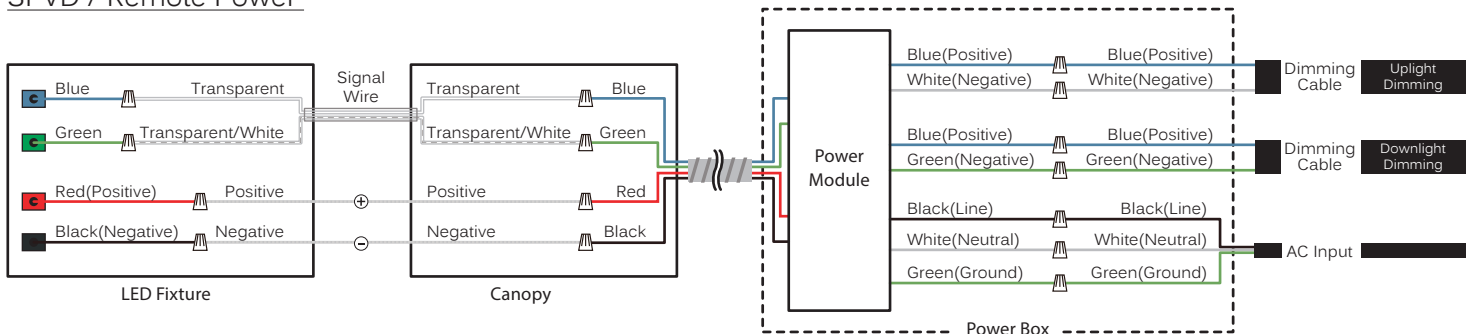

Troubleshooting

Only a certified electrician can service and troubleshoot product field issues. Always turn main power off before servicing fixture.

<p>Full Fixture does not illuminate</p>	<ul style="list-style-type: none"> • ENSURE THERE IS NO CONTACT OF POWERED SUSPENSION CABLES TO FIXTURE OR SHORT CIRCUIT WILL OCCUR! • ENSURE POWERED SUSPENSION CABLES ARE ATTACHED TO CORRECT POLARITIES ON FIXTURE AND INSIDE CANOPY. SEE LABELS/MARKING ON FIXTURE FOR DETAILS.
<p>Full fixture is flickering</p>	<ul style="list-style-type: none"> • POSSIBLE INTERMITTENT SHORTING BETWEEN POWERED SUSPENSION CABLES AND FIXTURE. ENSURE THERE IS NO CONTACT OF POWERED SUSPENSION CABLES TO FIXTURE. • 0-10V: Ensure polarity is correct for + and - connections. Swapping + and - connections can cause flickering. • LTE Dimming Models: Ensure a compatible LTE Forward Phase dimmer is connected to fixture. Call tech support for further information.
<p>Fixture section(s) do not illuminate</p>	<ul style="list-style-type: none"> • Possible loose low voltage DC + or - connection between LED boards or from LED driver to LED boards. • Some fixtures need multiple LED drivers. In this case, it's possible one of the drivers is defective, which will cause the LED con-
<p>Fixture does not dim</p>	<ul style="list-style-type: none"> • 0-10V, DMX, and DALI Dimming Models: Ensure polarity is correct for + and - connections. Swapping + and - connections can cause flickering. • LTE Dimming Models: Ensure a compatible LTE Forward Phase