

# ADVANCED HIGH CEILING Bolt - 150 W Standard Bracket



## IMPORTANT SAFETY INFORMATION. READ AND FOLLOW ALL SAFETY INSTRUCTIONS

IMPORTANT SAFETY INFORMATION. READ AND FOLLOW ALL SAFETY INSTRUCTIONS. Before wiring to power supply and during servicing or relamping, turn off power at fuse or circuit breaker. All servicing or relamping must be performed by qualified service personnel. Product must be grounded to avoid potential electric shock or other potential hazard. Product must be at locations and at heights and in a manner consistent with its intended use, and in compliance with Electrical Code and local codes.

SAVE THESE INSTRUCTIONS FOR FUTURE REFERENCE.

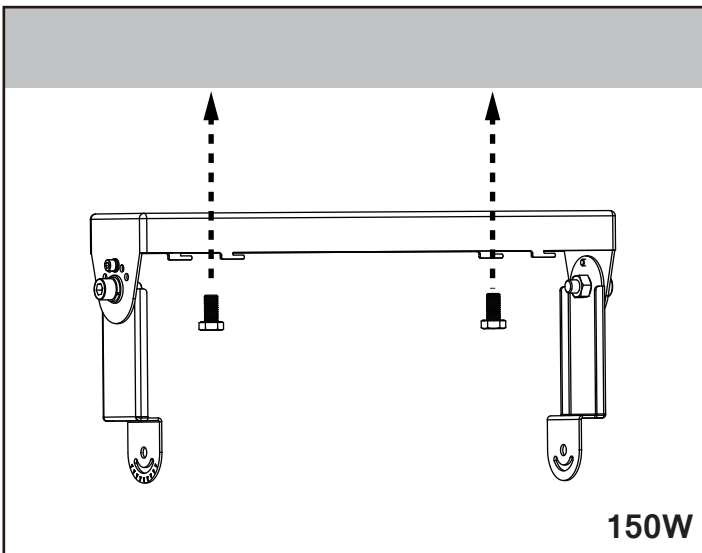
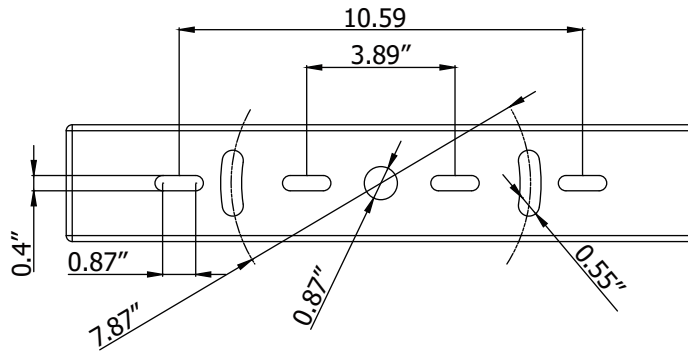

### Step 1

Secure bracket to a level surface with mounting hardware that is sufficient to support weight of the fixture and power box.

# ADVANCED HIGH CEILING Bolt - 150 W Standard Bracket

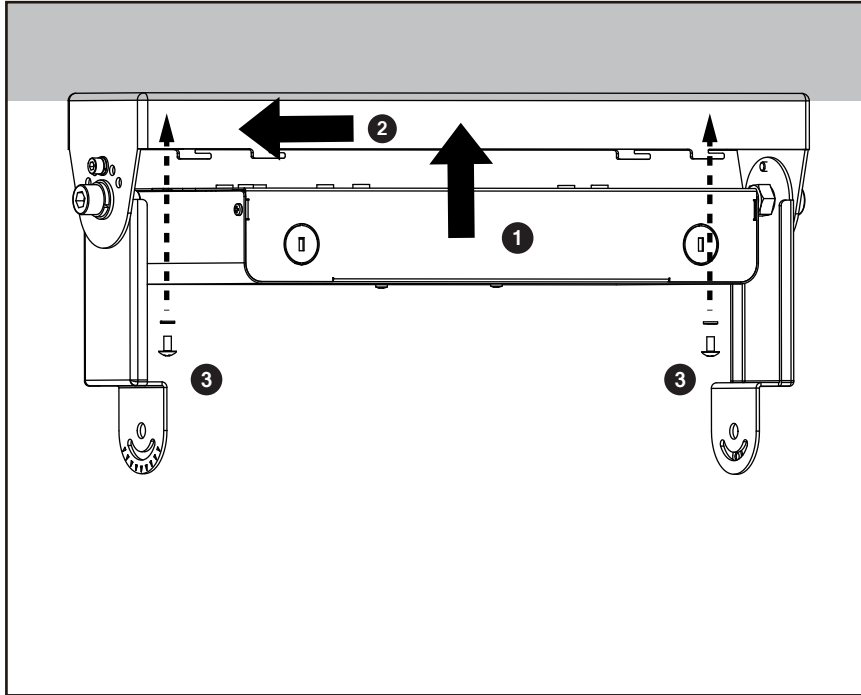

### Step 2

Slip the power box hook with fastener over the lock-in grooves allocated and fasten screws on either side to keep the power box in place.

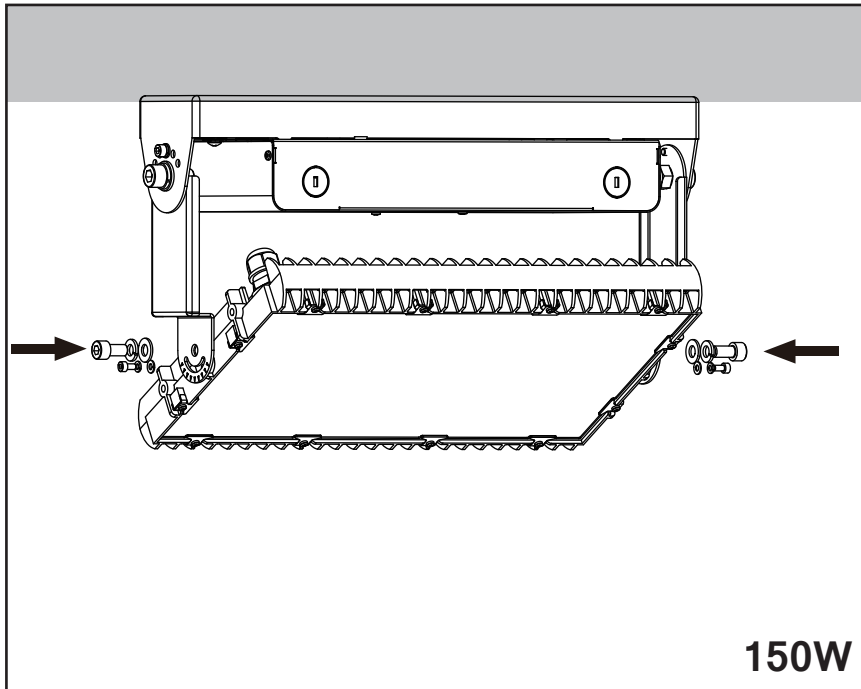

### Step 3

Secure the fixture to the bracket with provided screws.

# ADVANCED HIGH CEILING Bolt - 150 W Standard Bracket

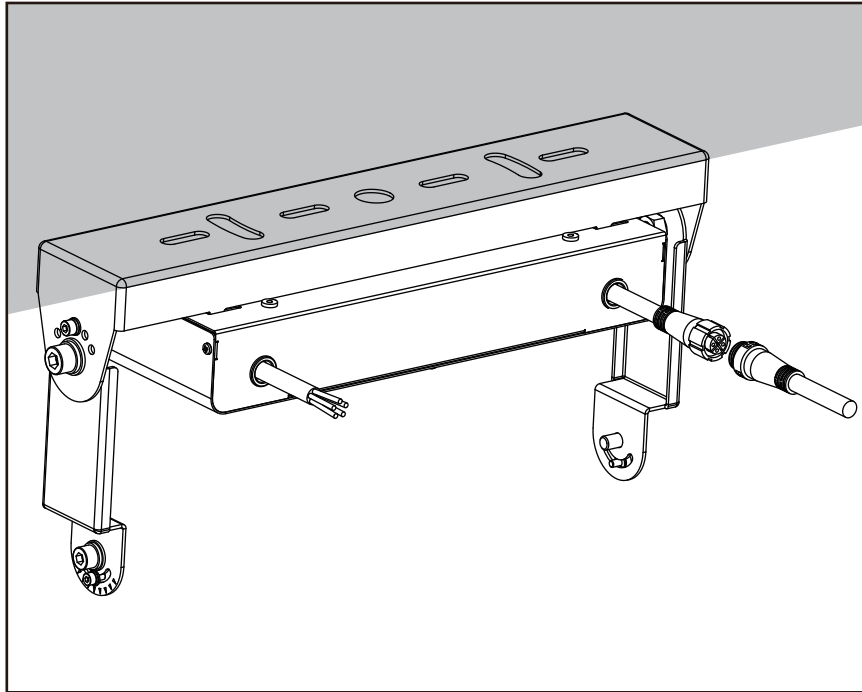

### Step 4

Connect quick connector cables between power box and fixture. Making sure to connect the AC wires (refer to wiring diagram).

### Wiring Diagram

Standard 0-10V (Bolt 150 W)

