

# ADVANCED HIGH CEILING Atria 6 - YokeMount



## IMPORTANT SAFETY INFORMATION. READ AND FOLLOW ALL SAFETY INSTRUCTIONS

IMPORTANT SAFETY INFORMATION. READ AND FOLLOW ALL SAFETY INSTRUCTIONS. Before wiring to power supply and during servicing or relamping, turn off power at fuse or circuit breaker. All servicing or relamping must be performed by qualified service personnel. Product must be grounded to avoid potential electric shock or other potential hazard. Product must be at locations and at heights and in a manner consistent with its intended use, and in compliance with Electrical Code and local codes.

**SAVE THESE INSTRUCTIONS FOR FUTURE REFERENCE.**

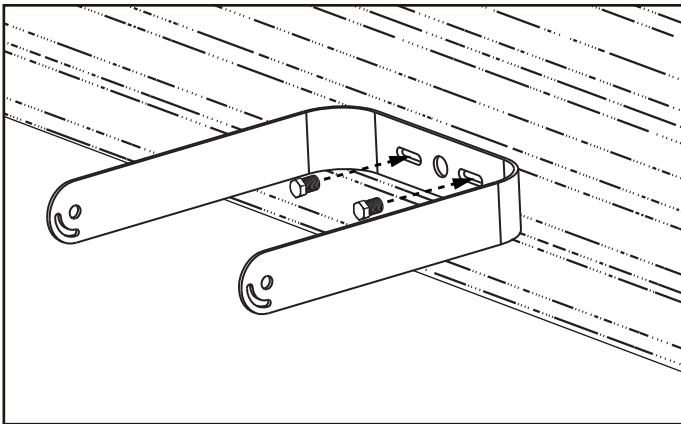

### Step 1

Tighten the screws through the Yoke Mount hole on the wall.

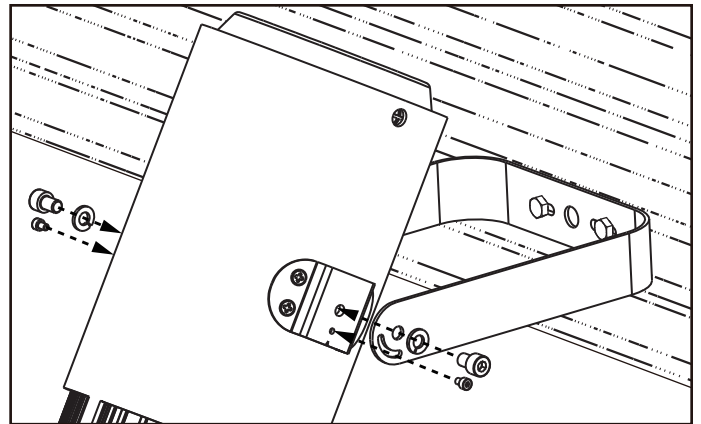

### Step 2

Tighten the screws through the Yoke Mount hole on the wall / ceiling.

# ADVANCED HIGH CEILING Atria 6 - YokeMount



## Wiring Diagram

### 0-10V / Superior 0-10V

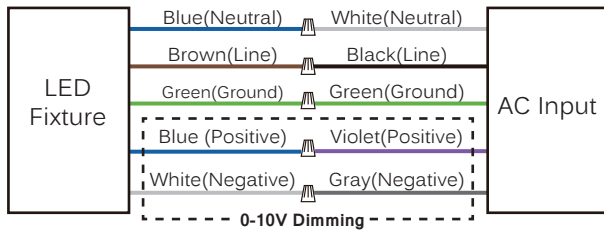

### Superior 0-10V Tunable White

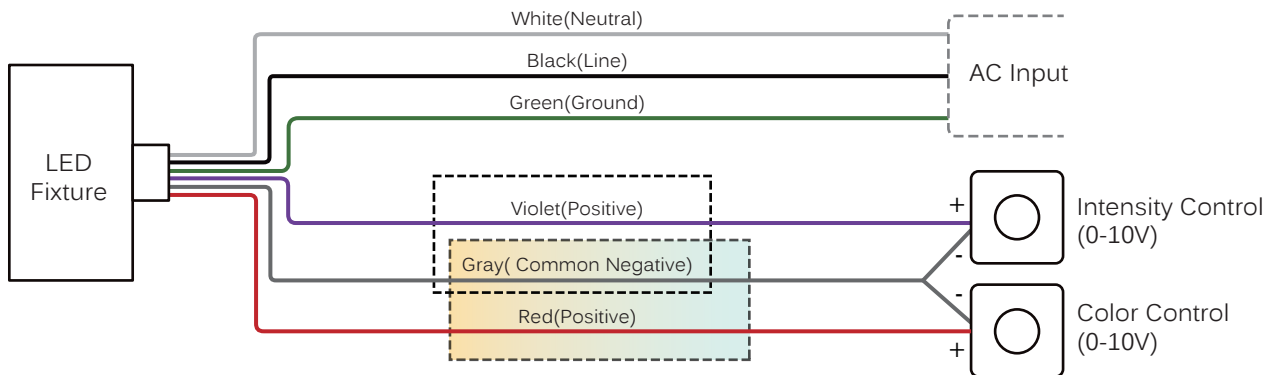

### ECO

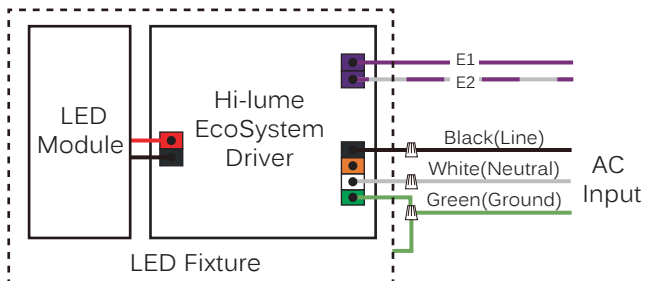

### TRIAC

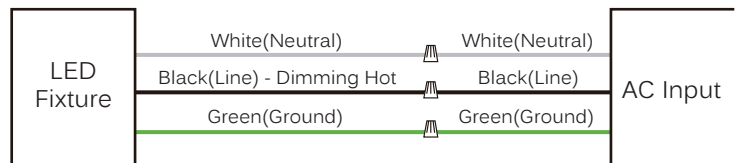

# ADVANCED HIGH CEILING Atria 6 - YokeMount



## Wiring Diagram

### DMX / DMX Tunable White

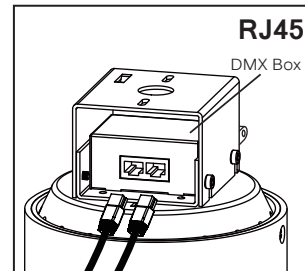
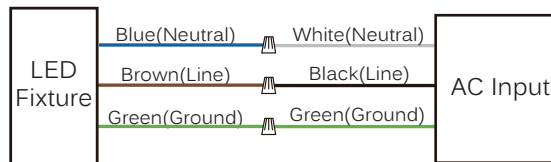

Connect DMX by using a standard shielded CAT5/6 cable.

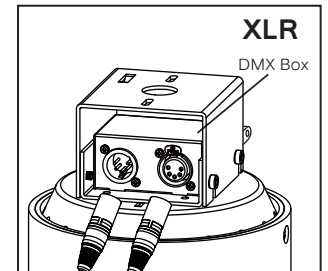

Connect DMX by using a standard DMX512 XLR cable with 5 pin in/out connector (by others).

**\*The last fixture has to be terminated with a DMX Terminator (by others).**

## Application note : Wiring for DMX/RDM lighting systems

DMX/RDM is a robust and reliable system for lighting control. However, if not implemented correctly, problems can arise such as random flashing of lights, erratic operation and delays in responding to commands. This document explains the best practices in DMX wiring.

### Important things to consider are:

1. DMX is a three-wire system. Use all three!
2. DMX is based on the EIA-485/RS-485 standard.
3. Always use cable specifically designed for DMX / RS-485. These cables have an impedance of 120Ω and a low capacitance. For instance : Belden 9841 or 3105a.
4. DMX must be terminated with a 120Ω resistor to prevent reflections.
5. A daisy chain topology should be used.
6. After **32** unit loads a repeater/booster should be used.  
(Important : For tunable white fixtures, After "**32**" unit loads a repeater/booster should be used.)
7. Keep cabling below 200 meters between the controller and the last driver.
8. It is generally considered good practice to provide separate DMX in and DMX out / DMX thru connections to your fixture to aid in installation. This can be in the form of pigtailed, RJ-45 connectors or 5-pin XLR connectors.
9. Use twisted pair cables with an impedance of 120Ω and a low capacitance.
10. UTP Cat5 or Cat6 network cable can also be used but have a slightly lower impedance of 100Ω.
11. If shielded cable is used, only connect shield to ground on one side (typically, the controller should have its shield terminal connected to ground).
12. Not following the above recommendations may seem to work at first, but can cause problems. Sometimes after weeks of seemingly normal operation.