

ADVANCED HIGH CEILING
Atria 4 - BIOS

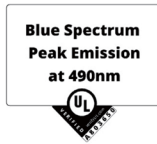

4-inch aperture round cylinder with BIOS SkyBlue® technology for brighter days and darker nights. Lumen package range from 880 lm - 1,300 lm.



- Melanopic to photopic ratio (m/p) of at least 0.70 @ 3000K
- Melanopic to photopic ratio (m/p) of at least 0.80 @ 3500K
- Melanopic to photopic ratio (m/p) of at least 0.90 @ 4000K
- Blue Spectrum Peak Emission at 490nm
- CRI 80+ and R9 >90

Quantity		Type	
Project		Note	

Electrical System

- 880lm (15W)
- 1300lm (25W)
- Power Input: Universal (120-277V)
- Operating Temperature: -13°F~104°F
- Surge Protection: 2.5KV
- Remote Emergency Pack: Bodine BSL20LV
- Power Factor Greater than 0.9

LED Technology

- 3000K, 3500K, 4000K
- 85 CRI
- Beam Angle: 15°, 25°, 35°, 60°, WD
- Glowing Ring Option
- Rated Life > 60,000 Hours (L70)

Advanced Dimming

(Proprietary VX Driver is incorporated to all dimming options for video flicker-free lighting)

- Standard 0-10V: dims to 10%
- Superior 0-10V: dims to 1%
- LTE: Hi-Lume 1% 2-wire LED Driver

Housing

- Diameter: 4.8" (122mm)
- Height: 12.6" (320mm)
- Material: Aluminum
- Weight: 8 lbs

Mounting

- Surface Mount
- Stem 2ft or 4ft; 45° Swivel Canopy Included
- Adjustable Aircraft Cable 10ft
- Wall Mount
- Yoke Mount

Warranty

- 5 year limited warranty

Listing

- ETL Damp Location Listed
- FCC
- CE



ADVANCED HIGH CEILING
Atria 4 - BIOS





How To Specify:

Ordering Example: AS4-15-30BIOSDY-UNV-SPV-35-BLK -STD -SUM

4-5 weeks lead time on over 75% of specifications.

Model	Wattage	CCT / CRI	Voltage	Dimming
AS4			UNV	
AS4	15 10W	30BIOSDY 3000K BIOS DYNAMIC	UNV 120-277V	SPV Superior 0-10V dims to dark
Atria 4	25 15W	35BIOSDY 3500K BIOS DYNAMIC		STV Standard 0-10V dims to 10%
		40BIOSDY 4000K BIOS DYNAMIC		LTE Hi-Lume 1% 2-wire LED Driver (120V forward phase only)
		30BIOSST 3000K BIOS STATIC		
		35BIOSST 3500K BIOS STATIC		
		40BIOSST 4000K BIOS STATIC		

Beam Angle	Finish	Rim Finish	Mounting	Accessories
15 15°	BLK Black	 STD Without Ring	SUM Surface Mount	DF* Diffuser
25 25°	WHT White		ST2 Stem 2ft	EMP Remote Emergency Pack
35 35°		 GLR Glowing Ring	ST4 Stem 4ft	
60 60°			AD10 Adjustable Cable 10ft	
WD* WIDE			YKM Yoke Mount	
	 BLK WHT		WLM Wall Mount	
*Please factor in change in lumen output with diffuser (-20% with WD; -12% with other degrees).			*Please factor in change in lumen output with diffuser (-20% with WD; -12% with other degrees).	

ADVANCED HIGH CEILING
Atria 4 - BIOS



Delivered Lumens*

Wattage	15W	25W
CCT	Beam Angle: 25°	
4000K	960 lm	1300 lm
3500K	930 lm	1285 lm
3000K	880 lm	1215 lm

*Tolerance 8%

Current Consumption

Wattage	120V	277V
15W	0.17A	0.08A
25W	0.23A	0.11A

Dimensions

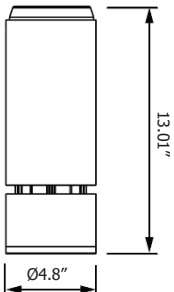

ADVANCED HIGH CEILING
Atria 4 - BIOS

Mounting Options

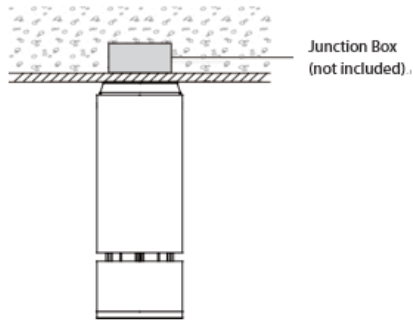

Surface Mount

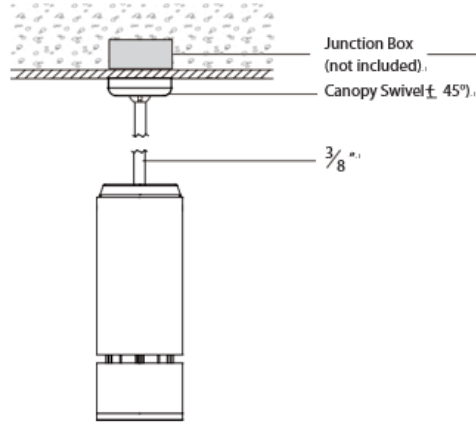

Stem

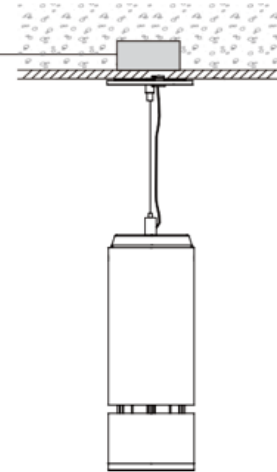

Adjustable Aircraft Cable

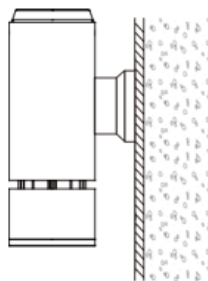

Wall Mount

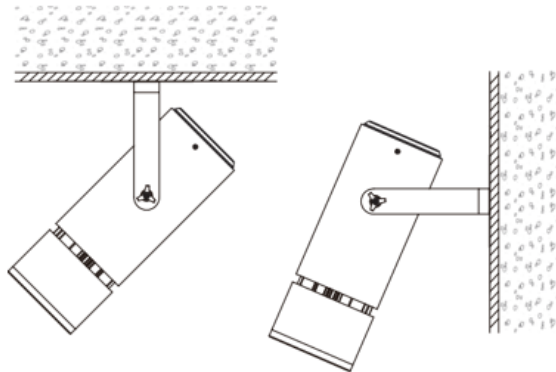

Yoke Mount

ADVANCED HIGH CEILING
Atria 4 - BIOS



Emergency Pack Lumen Output Table

CCT	3000K	3500K	4000K
Lumen	880 lm	930 lm	960 lm

Remote Emergency Pack

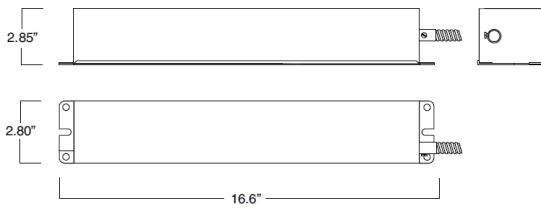

Junction Box
 (Not included)

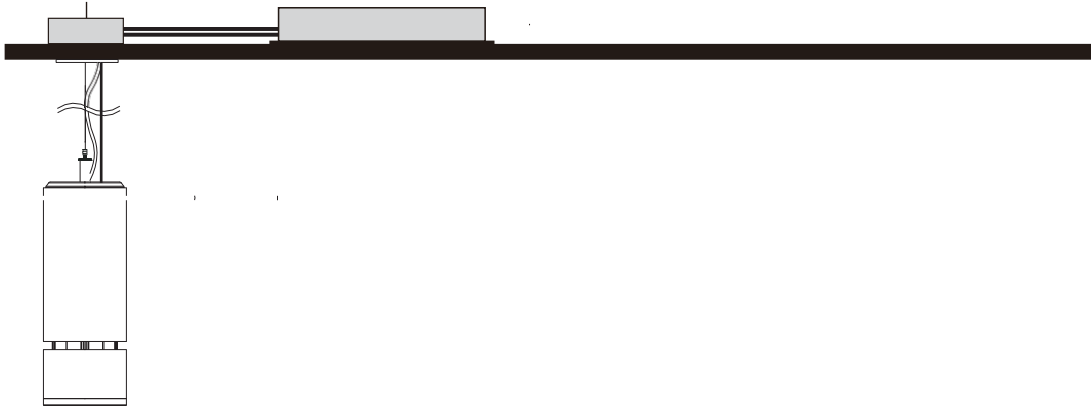

BIOS SkyBlue® Performance comparisons

BIOS LED Compared to Traditional LEDs

Spectral Power Composition and M/P Ratios

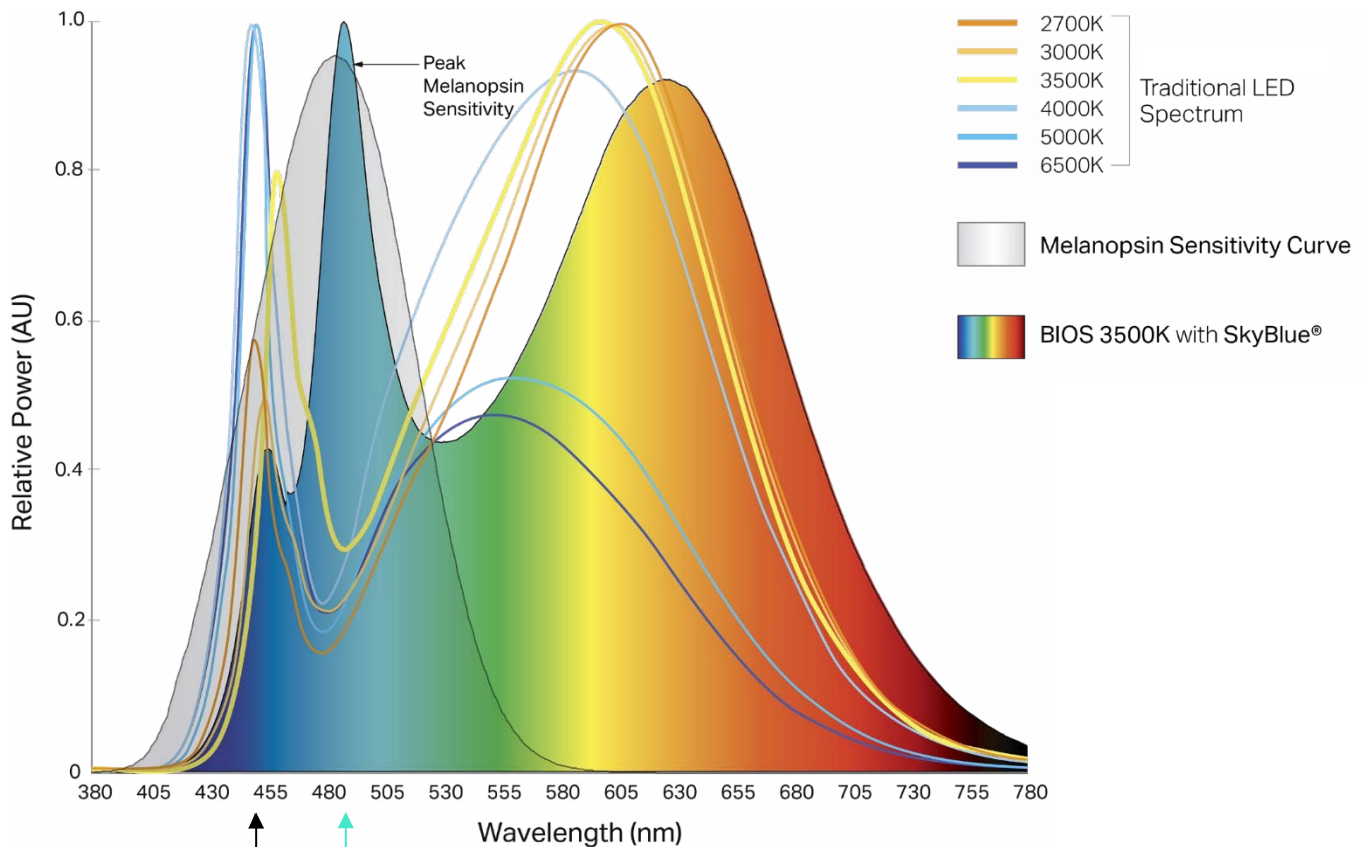

Traditional LED

BIOS delivers higher melanopic content than traditional LEDs, regardless of correlated color temperature (CCT), as shown in graph above.

Spectral power distribution more accurately indicates whether a light source addresses the melanopsin sensitivity curve than CCT.

BIOS SkyBlue[®] Static

M/P Ratios* and Nominal Performance

	BIOS Static Solutions		
CCT	3000K	3500K	4000K
CRI	82	83	83
R9	94	91	91
COI	3.0	3.1	3.1
SkyBlue Melanopic (M/P) Ratio	0.70	0.80	0.90

* M/P (melanopic to photopic) ratio indicates the ability of a light source to stimulate melanopsin, the protein contained in our non-visual photoreceptors that activates our circadian systems; it is used to help calculate EML (equivalent melanopic lux), one of the metrics used for circadian lighting in the WELL Building Standard.

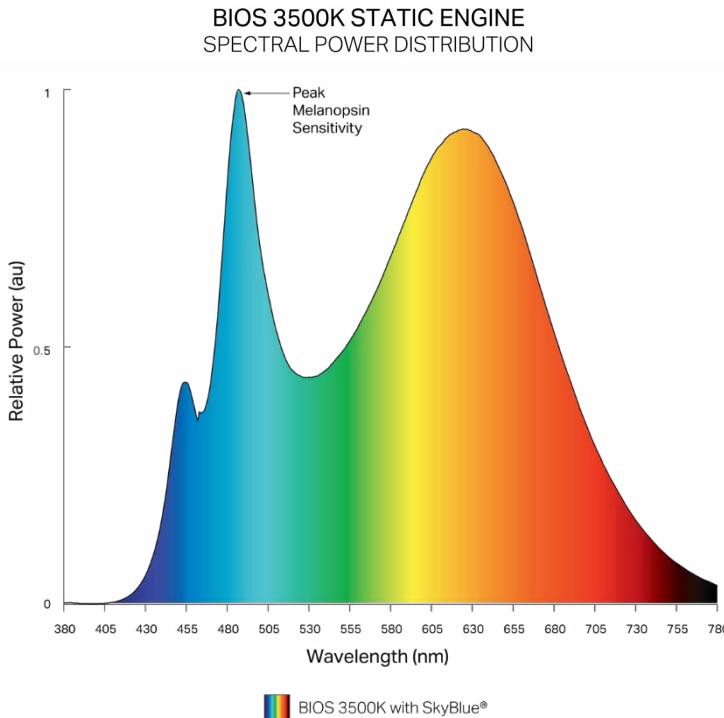

Static Spectrum

The static spectrum does not change spectral qualities throughout the day. It delivers a steady but invisible blue- light boost to white light throughout the day, maximizing circadian impact.

Applications

Suitable for day-active applications, such as schools and offices.

Static Light Engine

- ✓ **Supports daytime circadian stimulus**
- ✓ **No color tuning or correlated color temperature (CCT) adjustment required**
- ✓ **Color of light remains constant throughout the day:**
 - 490 nm 'blue boost' does not reduce during the day
 - Apparent CCT of 3000K, 3500K or 4000K remains constant
- ✓ **High melanopic to photopic (m/p) ratio**
 - While m/p ratio will remain constant if light level is dimmed, EML and CS values will be affected due to reduced vertical illuminance
- ✓ **CRI >80; R9 >90 at each CCT**
- ✓ **Simple controls**
 - Compatible with standard 0-10V dimming

BIOS SkyBlue® Dynamic

BIOS 3500K DYNAMIC ENGINE
SPECTRAL POWER DISTRIBUTION

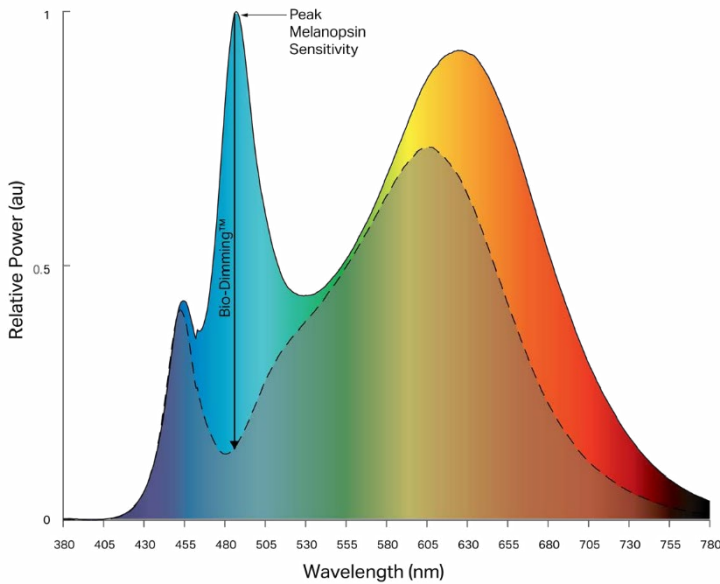

BIOS 3500K with SkyBlue® BIOS 3500K with Bio-Dimming™

M/P Ratios* and Nominal Performance

	BIOS Dynamic Solutions		
CCT	3000K	3500K	4000K
CRI	83	83	83
R9	90	90	90
COI	3.3	3.3	3.3
SkyBlue Melanopic (M/P) Ratio	0.74	0.83	0.95

* M/P (melanopic to photopic) ratio indicates the ability of a light source to stimulate melanopsin, the protein contained in our non-visual photoreceptors that activates our circadian systems; it is used to help calculate EML (equivalent melanopic lux), one of the metrics used for circadian lighting in the WELL Building Standard.

Applications

Suitable for 24-hour working environments such as hospitals, adult care facilities, laboratories, transportation control centers and applications involving shift work.

Dynamic Light Engine

- ✓ **Supports daytime circadian stimulus, reduces nighttime stimulus, based on user-defined schedule**
- ✓ **Uses the integral BIOS Bio-Dimming module to regulate SkyBlue stimulus**
- ✓ **SkyBlue content can be removed (via Bio-Dimming™) as day progresses, reducing melanopic impact while keeping light levels for visual tasks constant**
- ✓ **High melanopic to photopic (m/p) ratio**
- ✓ **CRI >80; R9 >90 at each CCT**
- ✓ **Simple controls:**
 - Uses any single-channel constant current LED driver with 0-10V dimming interface

Dynamic Spectrum

BIOS dynamic light engines use easy-to-program Bio-Dimming™ to provide high SkyBlue content during the day and remove SkyBlue content at night. The integral Bio-Dimming module allows the luminaire to deliver a steady but invisible boost of SkyBlue melanopic content to white light for daytime applications. The Bio-Dimming module then reduces the SkyBlue light over a specified amount of time, as programmed through lighting controls, while maintaining a constant light level. Once SkyBlue reaches its reduced level, light levels can be changed.

BIOS Bio-Dimming Settings with Dynamic Light Engine

DIMMER SETTING*	BIOS SKYBLUE*	LIGHT OUTPUT	
	100%* (Full On)	100%	Bio-Dimming™
	100%-0%	100%-90%	
	NO BIOS	~90%	Intensity Dimming
	NO BIOS	LINEAR DIMMING	

BIOS SkyBlue® maintained for maximum circadian impact.
Light output remains relatively constant.

BIOS SkyBlue® removed to provide minimal circadian impact.
Light output dims down linearly.

Circadian Lighting Feature

BIOS lighting provides industry-leading LED solutions that gives designers the tools they need, contributing toward satisfying Circadian Lighting Design Feature 54 under the WELL Building Standard v1 and Feature L03 under the WELL Building Standard v2.

BIOS SkyBlue® circadian lighting technology outperforms all traditional white LEDs on the market, and offers the highest melanopic to photopic lux ratio (m/p ratio) for a given color temperature. BIOS lighting solutions also meet other features within the WELL Light Concept, including color quality, offering 83+ CRI and ultra high R9 values at 85+, and visual comfort metrics - It's circadian lighting without compromise!

Feature L03

Circadian Lighting Design



Maintain Lighting Design Intent

BIOS provides the highest m/p ratio for a given CCT making it the most effective technology to help meet the EML vertical light requirements.

Feature L04

Glare Control



Visually Comfortable / Energy Efficient

With a higher m/p ratio, fewer fixtures are needed to illuminate the space, naturally minimizing the amount of glare.

Feature L07

Electric Light Quality

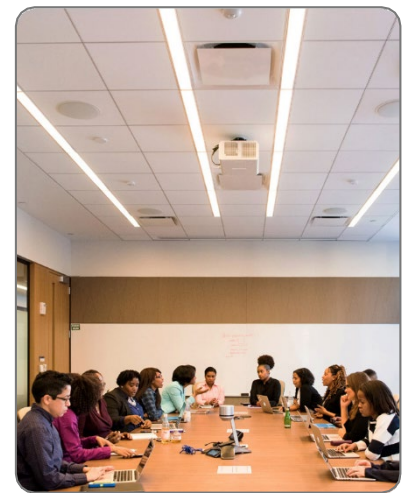

Desirable CCT / Great Color Quality

BIOS provides a CRI 85+ with an ultra high R9 > 50 for all color temperatures.

BIOS SkyBlue® LED

Traditional White LED



Increase Fixture Quantity

More light fixtures are required to achieve higher light levels on vertical surfaces, increasing the energy use and lighting power density within the space.

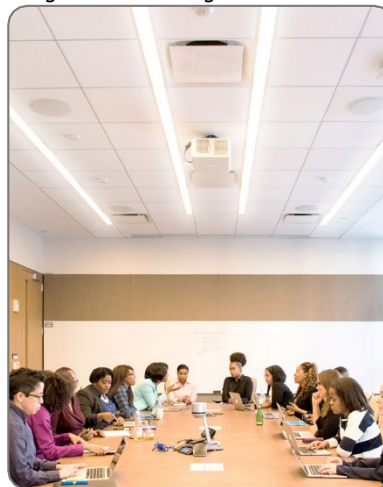

Increase Glare / Increase Energy

Higher output fixtures are needed within the space in order to meet EML targets which increases the energy use in the space as well as the likelihood of glare and visual discomfort.

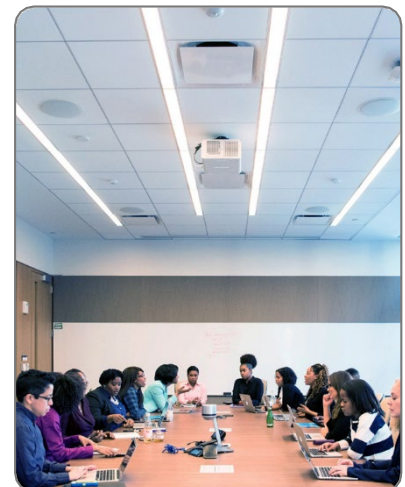

Increase CCT / Decrease Color Quality

Higher CCTs (5000K, 6500K) are required to achieve the target EML values but do not meet the R9 requirements.

IALD / LIRC WELL v2™ Guidelines

The following information and tables have been adapted from the IALD/LIRC WELL Guidelines 2019 Document for BIOS Illuminated Partners. The information below represents the minimum required information as outlined in the IALD/LIRC Guidelines document. Please refer to the '[2019 IALD-LIRC WELL-Guidelines.pdf](#)' for detailed information.

WELL™ | Light | Feature L03 - Circadian Lighting Design

CIRCADIAN LIGHTING DESIGN (1pt / 3pt Max)	BIOS Dynamic Engine			BIOS Static Engine		
	3000K	3500K	4000K	3000K	3500K	4000K
	83	83	83	83	83	83
Luminous Flux Multiplier (consult factory for values)						
Melanopic Ratio (R)*	0.74	0.83	0.95	0.70	0.80	0.90

Requirements for this feature:

Electric lighting is used to achieve light levels shown in the table below as measured on the vertical plane at eye level of the occupant. The light levels are achieved at least between the hours of 9 A.M. and 1 P.M. and may be lowered after 8 P.M.

For tabulated spectral power distribution (SPD) data please go to www.bioslighting.com

*Melanopic Ratio (R) is used to determine EML values. EML stands for Equivalent Melanopic Lux, and is defined by the photopic lux multiplied by a melanopic ratio, EML = LxR. For more information see "Measuring and Using Light in the Melanopsin Age" by Lucas, RJ et al.

WELL™ | LIGHT | FEATURE L04 - GLARE

GLARE CONTROL CRITERIA (3pt Max)	COMPLIANT	VALUE
a. Indirect (100% emission above horizontal)		
b. Unified Glare Rating (UGR)		
c. Shielding Angle		
d. Max. Luminance / Max. Intensity (45°C-90°C)		
e. Not Applicable		

Requirements for this feature:

For each luminaire type, manufacturers must provide a statement of compliance for one of the four methods or exclusion from the standard, plus supporting values as defined in the compliance category.

WELL™ | LIGHT | FEATURE L07 PART 1 COLOR RENDERING

ELECTRIC LIGHT QUALITY PART 1 - ENSURE COLOR RENDERING QUALITY (1pt Max)		COMPLIANT	VALUE
CRI	CRI > 90	--	
CRI, R9	CRI >80 with R9>50	✓	CRI = 83 R9 >90
IES TM-30-18	IES Rf ≥ 78, IES Rg ≥ 100, -1% ≤ IES Rcs, h1 ≤ 15%	--	
Not Applicable	Decorative, emergency, other	--	

WELL™ | LIGHT | FEATURE L07 PART 2 - FLICKER

ELECTRIC LIGHT QUALITY PART 2- MANAGE FLICKER (1pt Max)	COMPLIANT	VALUE
Meets IEEE 1789-2015 Standard Recommended Practice	✓	1000Hz / 0.8969%