

Atria 4 - Warm Dim



4-inch Cylinder utilizing Meteor Lighting's proprietary ColorFlip™ Warm Dim solution, that results in superior efficacy and heat management. This product is compatible with all existing 0-10V and DMX control systems. Bringing ambient lighting to your spaces.



Quantity	Type
Project	Note

Delivered Lumens*

Warm Dim	1900K						3000K
	7%	20%	40%	60%	80%	100%	
DMX CCT Signal (%)	7%	20%	40%	60%	80%	100%	
0-10V CCT Voltage	0.7	2	4	6	8	10	
65W	77 lm	347 lm	1040 lm	1964 lm	2965 lm	3850 lm	
45W	60 lm	270 lm	810 lm	1530 lm	2310 lm	3000 lm	
35W	51 lm	230 lm	689 lm	1301 lm	1964 lm	2550 lm	
25W	44 lm	198 lm	594 lm	1122 lm	1694 lm	2200 lm	
15W	32 lm	144 lm	432 lm	816 lm	1232 lm	1600 lm	

*Tolerance±8%

Electrical System

- 15W, 25W, 35W, 45W, 65W
- Power Input: 120V or 277V
- Operating Temperature: -40°F~104°F
- Surge Protection: 4KV
- Power Factor Greater than 0.9

LED Technology

- Warm Dim™ (Tuning White: 1900K ↔ 3000K)
- 85+ CRI
- Beam Angle: 40°, 60°, WD
- Rated Life > 60,000 hours (L70)

Advanced Dimming

(Proprietary VX Driver is incorporated to all dimming options for video flicker-free lighting)

- Superior 0-10V: dims to 1% (1 channel)
- DMX: high resolution dims to 0.1% (1 channel)
(Supports ANSI E1.20 RDM protocol)
- DALI: dims to 10%

Housing

- Diameter: 4.8" (122mm)
- Height: 12.6" (320mm)
- Material: Aluminum
- Weight: 8 lbs

Mounting

- Surface Mount
- Stem 2ft or 4ft; 45° Swivel Canopy Included
- Adjustable Aircraft Cable 10ft
- Yoke Mount

Warranty

- 5 year limited warranty

Listing

- ETL Damp Location Listed
- FCC
- CE



Atria 4 - Warm Dim



How To Specify:

Ordering Example:AS4-45-WDIM-U-DMX-40-STD-B-SUM

Model	Wattage	CCT / CRI	Voltage	Dimming
<input type="text" value="AS4"/>	<input type="text"/>	<input type="text" value="WDIM"/>	<input type="text"/>	<input type="text"/>
AS4	15 15W	WDIM 1900K - 3000K	UNV 120-277V	SPV Superior 0-10V dims to 1%
Atria 4	25 25W			DMX DMX dims to 0.1% (XLR Sockets)
	35 35W			DMX(RJ45) DMX dims to 0.1% (RJ45 Sockets)
	45 45W			DALI DALI dims to 10%
	65* 65W			

*Option is not compatible with TRIAC and ECO.

¹Option is not compatible with 65W.

*Wall Mount DMX does not include XLR / RJ45 sockets

Beam Angle	Finish	Rim Finish	Mounting	Accessories
<input type="text"/>	<input type="text"/>	<input type="text"/>	<input type="text"/>	<input type="text"/>
40 40°	BLK Black		SUM Surface Mount	DF* Diffuser
60 60°	WHT White		ST2 Stem 2ft	
WD* WIDE			ST4 Stem 4ft	
			AD10 Adjustable Cable 10ft	
			YKM Yoke Mount	
				
		GLR Glowing Ring		

* Please factor in change in lumen output with diffuser (-20% with WD ; -12% with other degrees).

¹ 2 DMX Positive / Negative wires

*Please factor in change in lumen output with diffuser (-20% with WD; -12% with other degrees).

Dimensions

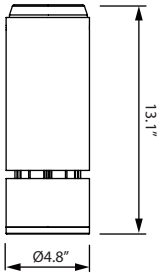

Mounting Options

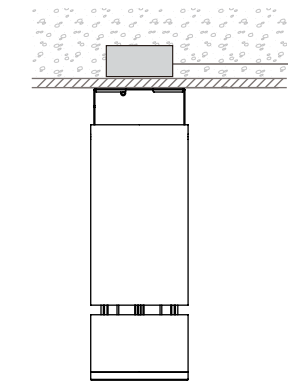

Surface Mount

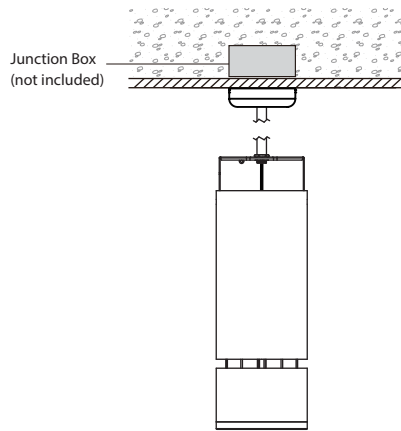

Stem

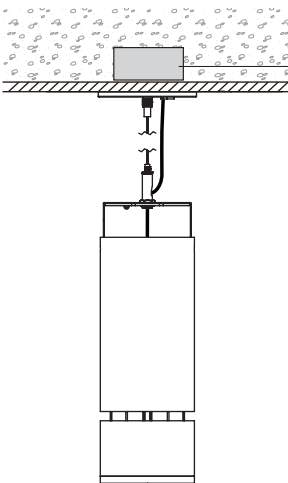

Adjustable Aircraft Cable

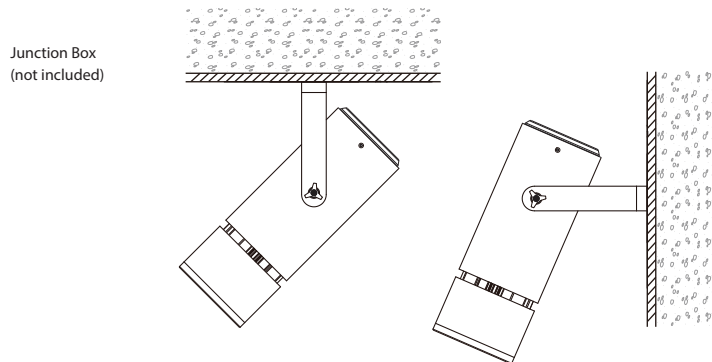

Yoke Mount

ADVANCED HIGH CEILING
Atria 4 - Warm Dim



DMX Requirements*

The Atria 4 Warm Dim fixture with DMX is a ONE CHANNEL DMX unit.

When placing order, please indicate DMX address. (The DMX address will be listed on the back of the fixture.)

The LED fixture provide RJ45 Socket or XLR socket to connect. (DMX cable NOT included.)

The final fixture should be terminated by the use of DMX Terminator (by others).

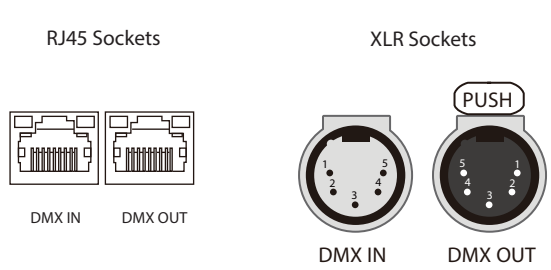

CONNECTION	RJ45 (CAT5e)	5-PIN XLR
Common	WHITE/BROWN(PIN7) & BROWN(PIN 8)	PIN 1
Signal -	ORANGE(PIN 2)	PIN 2
Signal +	WHITE/ORANGE(PIN 1)	PIN 3
Spare	-	PIN 4
Spare	-	PIN 5

