

ADVANCED HIGH CEILING

# Atria 10 - Standard



10-inch Cylinder with aesthetic design and minimal visual impact suited for remodel or new construction.

- **Outdoor/Natorium Rating**  
(Please refer to **Outdoor/Natorium Version spec sheet**)
- **Tunable White**  
(Please refer to **Tunable White Version spec sheet**)
- **Warm Dim**  
(Please refer to **Warm Dim Version spec sheet**)
- **W+RGB**  
(Please refer to **W+RGB Version spec sheet**)

Quantity		Typ	
Project		Note	

## Electrical System

- 9719lm (80W)
- 12634lm (110W)
- 16451lm (140W)
- 21204lm (180W)
- 24867lm (220W)
- Power Input: Universal (120-277V)
- Operating Temperature: -13°F~112°F
- Surge Protection: 4KV
- Power Factor Greater than 0.9
- Remote Emergency Pack: Bodine
- Power Factor Greater than 0.9BSL20LV

## LED Technology

- 2700K, 3000K, 3500K, 4000K
- 85 CRI, 93 CRI
- Beam Angle: 30°, 45°, 55°, WD
- Rated Life > 60,000 hours (L70)

## Advanced Dimming

(Proprietary VX Driver is incorporated to all dimming options for video flicker-free lighting)

- Standard 0-10V: dims to 10%
- Superior 0-10V: dims to 1 %
- DMX: high resolution dims to 0.1%
- (Supports ANSI E1.20 RDM protocol)

**80W/110W/140W/180W only:**  
 LTE : Hi-Lume 1% 2-wire LED Driver (120V forward phase only)  
 LDE1 : Hi-Lume 1% EcoSystem LED Driver with Soft-on, Fade-to-Black (UNV only)

## Housing

- Diameter: 9.4" (238mm)
- Height: 20.5" (520mm)
- Material: Aluminum
- Weight: 30 lbs

## Mounting

- Stem 2ft or 4ft; 45° Swivel Canopy Included
- Adjustable Aircraft Cable 10ft

## Warranty

- 5 years limited warranty.

## Listing

- ETL Damp Location Listed
- DLC Listed
- FCC
- CE



Not all Atria 10 are DLC qualified. For all qualified products. Please visit: [www.designlights.org/qpl](http://www.designlights.org/qpl)

# Atria 10 - Standard



## How To Specify:

**Ordering Example: AS10-220-408-UNV-DMX-45-BLK-ST2**

**4-5 weeks lead time on over 75% of specifications.**

Model	Wattage	CCT / CRI	Voltage	Dimming
<b>AS10</b>			<b>UNV</b>	
AS10 Atria 10	<b>80</b> 80W <b>110</b> 110W <b>140</b> 140W <b>180</b> 180W <b>220</b> 220W	<b>278</b> 2700K / CRI85 <b>308</b> 3000K / CRI85 <b>358</b> 3500K / CRI85 <b>408</b> 4000K / CRI85 <b>279</b> 2700K / CRI85 <b>309</b> 3000K / CRI85 <b>359</b> 3500K / CRI85	<b>UNV</b> 120-277V	<b>STV</b> Standard 0-10V dims to 10% <b>SPV</b> Superior 0-10V dims to dark <b>DMX</b> DMX dims to 0.1% (XLR Sockets) <b>DMX(RJ45)</b> DMX dims to 0.1% (RJ45 Sockets) <b>LTE</b> Hi-Lume 1% 2-wire LED Driver (120V forward phase only) <b>LDE1</b> Hi-Lume 1% EcoSystem LED Driver with Soft-on, Fade-to-Black (UNV only)

Beam Angle	Finish	Mounting	Accessories
<b>30</b> 30° <b>45</b> 45° <b>55</b> 55° <b>WD*</b> WIDE	<b>BLK</b> Black <b>WHT</b> White	<b>ST2</b> Stem 2ft <b>ST4</b> Stem 4ft <b>AD10</b> Adjustable Cable 10ft	<b>SPD</b> <sup>1</sup> Surge Protector <b>HC</b> <sup>2</sup> Honeycomb Louver <b>EMP</b> Remote Emergency Pack
<p>*Please factor in change in lumen output with diuser (-20% with WD ; -12% with other degrees).</p>			<p><sup>1</sup>Surge protector for up to 10KV.Applicable for unstable mains or facilities using high power machinery.</p> <p><sup>2</sup>Please factor in change in lumen output of 30%</p>

### DesignLights Consortium™ Qualified Luminaires:

DLC QPL Model Number : AS10-220-408

Not all product variations listed on this page are DLC qualified.

To ensure that a specific model is qualified, visit [www.designlights.org/search](http://www.designlights.org/search).

# Atria 10 - Standard

### Delivered Lumens\*

Wattage \ CCT	80W	110W	140W	180W	220W
CRI:85 / Beam Angle: 30°					
4000K	9719 lm	12634 lm	16451 lm	21204 lm	24867 lm
3500K	9380 lm	12190 lm	15880 lm	20646 lm	24212 lm
3000K	9040 lm	11751 lm	15309 lm	20088 lm	23558 lm
2700K	8454 lm	10990 lm	14309 lm	18972 lm	22249 lm

### Current Consumption

Wattage \ Volt	120V	277V
80W	0.73A	0.32A
110W	1.01A	0.44A
140W	1.28A	0.56A
180W	1.65A	0.71A
220W	2.02A	0.87A

\*Tolerance±8%

### Dimensions

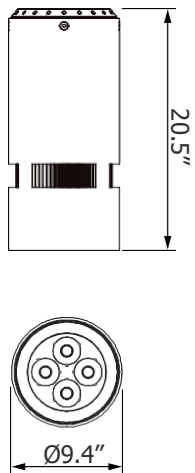

### Mounting Options

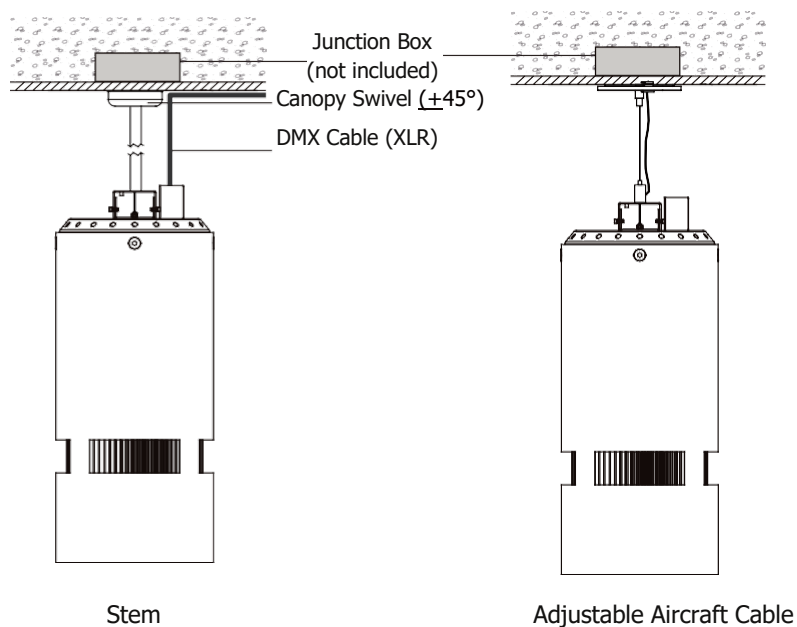

**DMX Requirements**

The Atria 10 LED fixture with DMX is a **ONE CHANNEL DMX unit**.

**When placing order, please indicate DMX address.** (The DMX address will be listed on the back of the fixture.) The LED fixture provide RJ45 Socket or XLR socket to connect. (DMX cable NOT included.)

The final fixture should be terminated by the use of DMX Terminator (by others).

CONNECTION	RJ45 (CAT5e)	5-PIN XLR
Common	WHITE/BROWN(PIN7) & BROWN(PIN 8)	PIN 1
Signal -	ORANGE(PIN 2)	PIN 2
Signal +	WHITE/ORANGE(PIN 1)	PIN 3
Spare	-	PIN 4
Spare	-	PIN 5

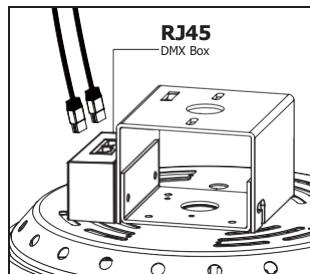
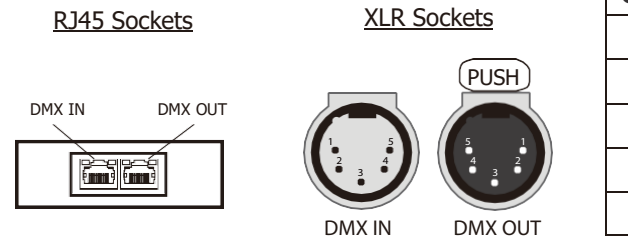

Connect DMX by using a standard shielded CAT5/6 cable.

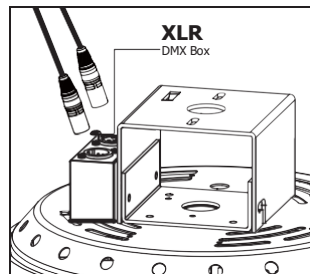

Connect DMX by using a standard DMX512 XLR cable with 5 pin in/out connector (by others).

**Compatible TRIAC Dimmer List**

LUTRON PART NO.

RRD-6NA-	RRT-G5NEW-	RRT-GH	HQRD-10ND-	HQRT-GH	HQRD-HN	PD-10NXD-
RRD-6ND	RRT-G25LW-	HQRD-6NA-	MRF2-6ND-120-	HQRT-G25LW-	GT-250M-	PD-5NE-
RRD-10ND-	RRD-HN	HQRD-6ND-	MRF2S-6ND-120-	HQRT-G5NEW-	GTJ-250M-	

**Remote Emergency Pack**

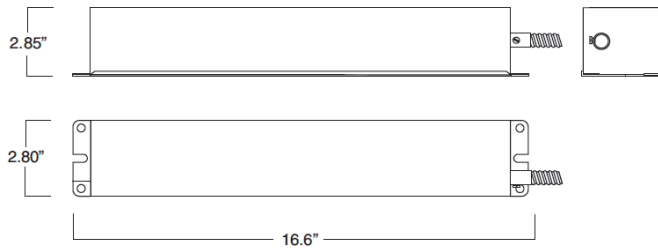

**Mounting with standard ceiling recessed Junction BOX**

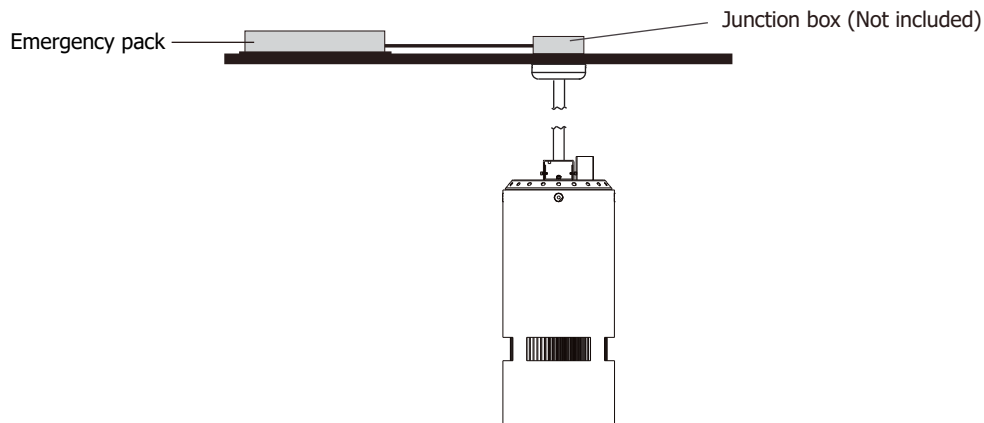

**Emergency Pack Lumen Output Table**

CCT	2700K	3000K	4000K
Lumen	1640 lm	1760 lm	1890 lm