

# DUO 6

SPECIFICATION SHEET  
TUNABLE WHITE

## ELEGANT 6 INCH UP AND DOWN LUMINAIRE

### Housing

Diameter : Ø6.37" | Height : 20" | Weight : 15.2 lbs

### Material

Housing : Extruded Aluminum

Lens : Clear polycarbonate

### Power Input

Downlight : 15W, 25W, 50W | 120-277V

Uplight : 15W, 25W | 120-277V

### Lumen Output

Downlight : 1,760 lm (15W), 2,180 lm (25W), 4,080 lm (50W)

Uplight : 1,760 lm (15W), 2,180 lm (25W)

### Dimming

Superior 0-10V : Dims to 1%

DMX : High resolution dims to 0.1% (RJ45 only)

(Supports ANSI E1.20 RDM protocol)

### Color Quality

CRI 85+ | UGR ≤ 19

### Rated Life

> 100,000 Hours (L70)

### Finish



Black



White

### Color Temperature



ColorFlip™ Tunable White  
2700K ↔ 6500K

### Optics



40°  
UP/DOWN



60°  
UP/DOWN



WIDE  
UP/DOWN

### Mounting



Power Line



Power Line  
Remote Power

### Warranty

5 Year limited warranty

### Listing



## Revolutionary Mounting System

With a unique High Lumen Power Suspension System, the Duo series is an elegant, cable-free and aesthetic up and downlight solution.

With a seamless connector and hidden signal wire, this luminaire seamlessly blends into your environment and space.

Duo gives you perfect optics with intuitive design making it a decorative element that adds a touch of class.

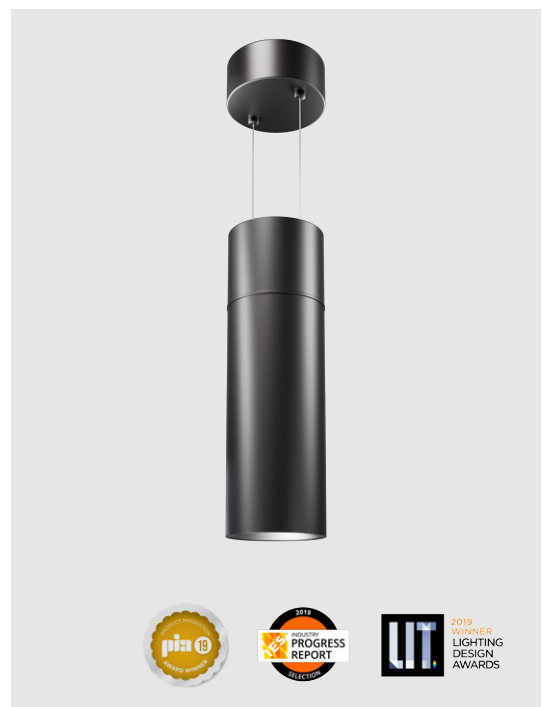



**TECHNICAL DETAILS**

**Electrical**

- Downlight : 1,760 lm (15W), 2,180 lm (25W), 4,080 lm (50W)
- Uplight : 1,760 lm (15W), 2,180 lm (25W)
- Power Input : Universal (120-277V)
- Operating Temperature : -13°F~104°F
- Surge Protection : Built-in is 2.5KV
- Power Factor Greater than 0.9

**LED Features**

- Color Temperature : 2700K, 3000K, 3500K, 4000K
- CRI 85+
- UGR ≤ 19
- Long lasting LED luminaire tested under TM21 lumen maintenance L70 @ 100,000 Hrs

**Optics**

- Precision molded high transmittance clear lenses
- Beam Angle : Up&Down: 40°, 60°, WD

**Advanced Dimming**

- Proprietary VX Driver™ is integrated across all dimming options, delivering video flicker-free performance and full compliance with IEEE 1789.

**With Signal Wire**

- Superior 0-10V : dims to 1%
- DMX : high resolution dims to 0.1% (RJ45 only) (Supports ANSI E1.20 RDM protocol)

**Housing**

- Diameter : Ø6.37"
- Height : 20"
- Material : Extruded Aluminum
- Weight : 15.2 lbs
- Canopy Height : 2.95"

**Mounting**

- Power Line Mount 2ft, 4ft, 6ft, 8ft, 10ft (Canopy Height : 2.95")
- Power Line Mount 2ft, 4ft, 6ft, 8ft, 10ft with Remote Power (Canopy Height : 0.84")

**Warranty**

- 5-year limited warranty

**Listing**

- ETL Listed

**PERFORMANCE SUMMARY\***

ColorFlip™	2700K	3000K	3500K	4000K	4500K	5000K	5700K	6500K
<b>DMX</b> CCT SIGNAL (%)	0%	10%	25%	45%	60%	70%	85%	100%
<b>0-10V</b> CCT VOLTAGE	0	1	2.5	4.5	6	7	8.5	10
<b>30W</b> UP (15W)	1,500lm	1,565lm	1,630lm	1,695lm	1,760lm	1,740lm	1,720lm	1,700lm
<b>30W</b> DOWN (15W)	1,500lm	1,565lm	1,630lm	1,695lm	1,760lm	1,740lm	1,720lm	1,700lm
<b>50W</b> UP (25W)	1,960lm	2,015lm	2,070lm	2,125lm	2,180lm	2,175lm	2,165lm	2,160lm
<b>50W</b> DOWN (25W)	1,960lm	2,015lm	2,070lm	2,125lm	2,180lm	2,175lm	2,165lm	2,160lm
<b>75W</b> UP (25W)	1,960lm	2,015lm	2,070lm	2,125lm	2,180lm	2,175lm	2,166lm	2,160lm
<b>75W</b> DOWN (50W)	3,500lm	3,630lm	3,730lm	3,930lm	4,080lm	4,035lm	3,990lm	3,940lm
<b>CRI</b>	<b>85</b>	<b>86</b>	<b>87</b>	<b>88</b>	<b>89</b>	<b>88</b>	<b>87</b>	<b>86</b>

\*Lumen Multiplier 40° 60° baseline 0.82

**PERFORMANCE SUMMARY**

Current Consumption		
WATTAGE / VOLT	120V	277V
30W	0.28A	0.12A
50W	0.46A	0.20A
75W	0.69A	0.30A

**PHOTOMETRICS**

Below is a typical photometric representation of the Duo 6 fixture. Please download IES files to ensure exact photometric value.

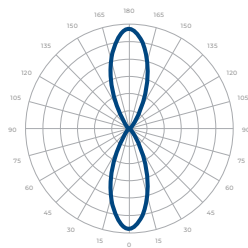

40°

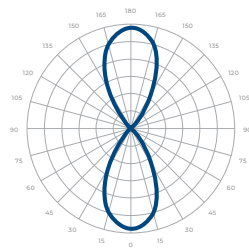

60°

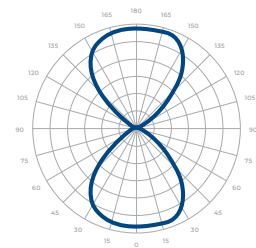

WIDE

**DMX REQUIREMENTS**

The Duo 6 Tunable White fixture with DMX unit has **two channels** per fixture (1 to control intensity, 1 to control color). When placing an order, please indicate DMX address. (The DMX address will be listed on the back of the fixture). Do not connect more than 32 fixtures per DMX daisy chain.

Fixture	DMX Address	
	Intensity Control (ex. X)	Color Control (ex. X+1)
#1	1	2
#2	3	4
#3	5	6

**DMX REQUIREMENTS**

The fixture can be connected with RJ45 sockets. DMX cables **are not** included; please refer to compatible DMX cabling list for more information. The final fixture on each daisy chain should be terminated by the use of a DMX terminator purchased from a 3rd party or from Meteor.

CONNECTION	RJ45 (CAT5e)
Common	WHITE/BROWN(PIN7) & BROWN (PIN 8)
Signal -	ORANGE (PIN 2)
Signal +	WHITE/ORANGE (PIN 1)
Spare	-
Spare	-

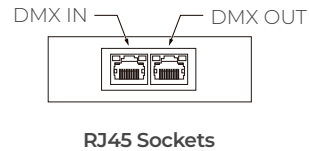

**COMPATIBLE DMX CABLING LIST**

DMX uses a cable consisting of two twisted pairs plus a shield to carry data. The cable must be specifically impedance matched for the digital DMX signal, meaning that microphone cable or other non-rated cable **must not be used to carry DMX**. Network cable (Cat5, 5e or 6 cable) may be used to carry DMX in an installation; however special consideration must be given to shielding and termination. Under no circumstances should solid core cable like Cat5 be terminated into a screw down connector.

Meteor recommends the use of Belden 9729 or Belden 9841 for DMX installation. Belden 9729/9841 is a two pair cable, which allows for a spare pair for 'out and back' type terminations if needed.

**DIMENSIONS**

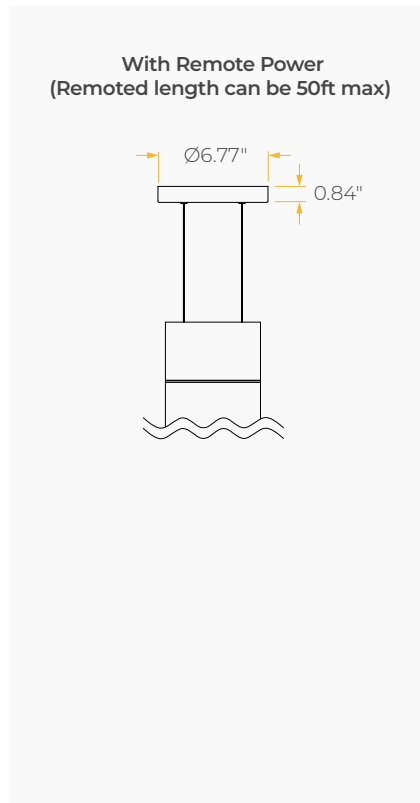
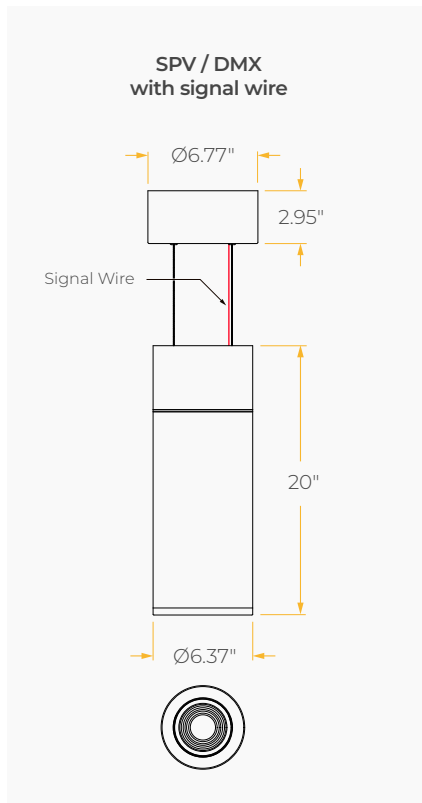

**MOUNTING OPTIONS\***

\*Junction Box not included

**Power Line Mount with  
High Lumen Power Suspension**

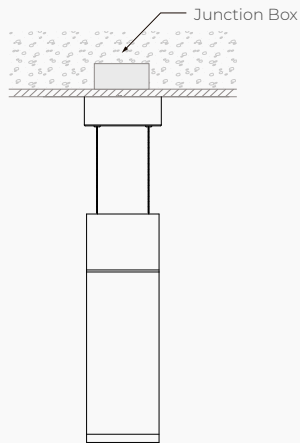

**Power Line Mount with High Lumen  
Power Suspension and Remote Power**

