

REV 8 PRIME

QUIET CEILING DESIGN HIGH LUMEN RECESSED DOWNLIGHT

Housing

Aperture : Ø8.1" | Oversize Trim : 8.46" | Ceiling Cutout : 8.25"
Maximum Ceiling Thickness : 1.5" | Height : 8.6" | Weight : 17.63 / 18.82 lbs

Material

Housing : Forged Aluminum Heatsink
Reflector : Flow Forming Aluminum

Power Input

185W, 225W | 120V, 277V

Lumen Output

17,505 lm (185W), 21,320 lm (225W)

Dimming

Superior 0-10V: dims to 1%, dims to dark
DMX : High resolution dims to 0.1%

Color Quality

CRI 85+

Rated Life

> 60,000 Hours (L70)

Finish



Black



White

Color Temperature



ColorFlip™ Tunable White
2700K ↔ 6500K

Optics



45°



55°



Wide

Warranty

5 Year limited warranty

Listing



SPECIFICATION SHEET NEW CONSTRUCTION - TUNABLE WHITE

Precision Engineered For High Performance.

8-inch aperture high lumen recessed downlight utilizing Meteor Lighting's proprietary ColorFlip™ Tunable White solution, that results in superior efficacy and heat management.

This product is compatible with all existing 0-10V and DMX control systems. Bringing human centric lighting to your spaces.

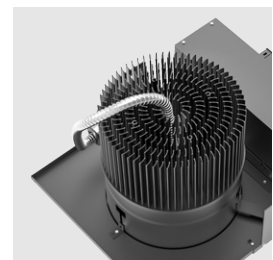
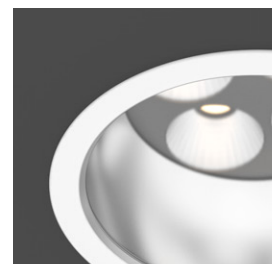
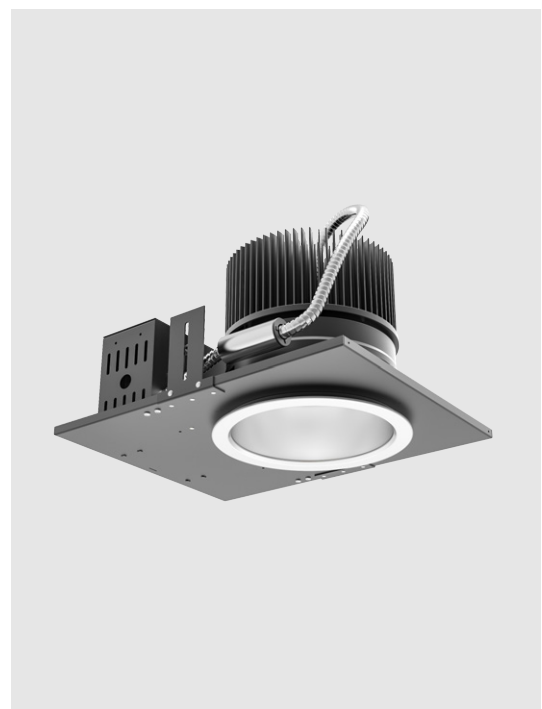

SPECIFICATION

PROJECT NAME	DATE
<input type="text"/>	<input type="text"/>
CATALOG #	QUANTITY
<input type="text"/>	<input type="text"/>

R8PN	MODEL	REV 8 PRIME WITH NEW CONSTRUCTION FRAME		
<input type="text"/>	WATTAGE	185 185W	225 225W	
TNW	CCT / CRI	TNW 2700K-6500K		
<input type="text"/>	VOLTAGE	120 120V	277 277V	
<input type="text"/>	DIMMING	SPV Superior 0-10V dims to 1%, dims to dark	DMX DMX dims to 0.1% (XLR Sockets)	DMX(RJ45) DMX dims to 0.1% (RJ45 Sockets)
<input type="text"/>	BEAM ANGLE	45 45°	55 55°	WD¹ Wide (With diffuser)
<input type="text"/>	FINISH*	BLK Black	WHT White	
<input type="text"/>	ACCESSORIES	NO Accessories SCA810 Sloped Ceiling Adapter 8°-12° SCA825 Sloped Ceiling Adapter 23°- 27°	DF² Diffuser SCA815 Sloped Ceiling Adapter 13°-17° 2CPL 2' X 2' X 1" Custom Metal Ceiling Panel	SPD³ Surge Protector SCA820 Sloped Ceiling Adapter 18°-22°

¹ Please factor in change in lumen output with WD -20%
² Please factor in change in lumen output with diffuser (-20% with WD; -12% with other degrees)
³ Surge protector for up to 10KV. Applicable for unstable mains or facilities using high-power machineries
 * Finish indicates trim only, with standard matte silver reflector

TECHNICAL DETAILS

Electrical

- 17,505 lm (185W)
- 21,320 lm (225W)
- Power Input: 120V or 277V
- Operating Temperature: -13°F~112°F
- Surge Protection: Built-in is 4KV
- Power Factor Greater than 0.9

LED Features

- ColorFlip™ Tunable White 2700K ↔ 6500K
- CRI 85+
- Long lasting LED luminaire tested under TM21 lumen maintenance L70 @ 60,000 Hrs

Optics

- Flow Forming Aluminum Reflector
- Beam Angle : 45°, 55°, Wide (With diffuser)

Advanced Dimming

- Proprietary VX Driver™ is incorporated to all dimming options for video flicker-free lighting
- Superior 0-10V: dims to 1%, dims to dark
- DMX : High resolution dims to 0.1% (Supports ANSI E1.20 RDM protocol)

New Construction Housing

- Aperture : Ø8.1"
- Height : 8.6"
- Weight : 17.63 lbs/ 18.82 lbs
- Material : Forged Aluminum Heatsink
- Non-IC Rated, insulation must be kept >1ft from housing
- Oversize Trim : 8.46"
- Ceiling Cutout : 8.25"
- Maximum Ceiling Thickness : 1.5"
- Tool-less top access allows service from above and below
- Light engine, optics, and driver(s) accessible from below ceiling

*Note: C-Channel / Mounting Channels / T-Bar Hangers are purchased from a third party

Warranty

- 5-year limited warranty

Listing

- ETL Damp Location Listed
- FCC

PERFORMANCE SUMMARY*

ColorFlip™	2700K	3000K	3500K	4000K	4500K	5000K	5700K	6500K
DMX CCT Signal (%)	0%	10%	25%	45%	60%	70%	85%	100%
0-10V CCT Voltage	0	1	2.5	4.5	6	7	8.5	10
185W	16,420lm	17,060lm	17,320lm	19,170lm	19,150lm	18,960lm	18,400lm	17,505lm
225W	20,075lm	20,830lm	21,110lm	23,330lm	23,285lm	23,090lm	22,455lm	21,320lm
CRI	85	86	87	88	88	87	86	85

* Beam Angle 45° Tolerance ±8%

PHOTOMETRICS

Below is a typical photometric representation of the Rev 8 Prime fixture. Please download IES files to ensure exact photometric value.

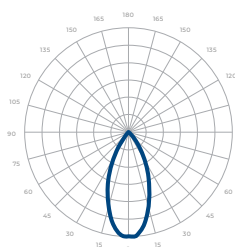

45°

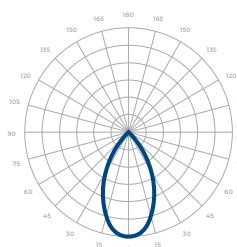

55°

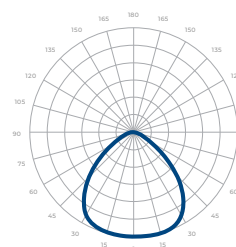

WIDE

DMX REQUIREMENTS

The Rev 8 Tunable White fixture with DMX unit has **two channels** per fixture (1 to control intensity, 1 to control color). When placing an order, please indicate DMX address. (The DMX address will be listed on the back of the fixture). Do not connect more than 32 fixtures per DMX daisy chain.

Fixture	DMX Address	
	Intensity Control (ex. X)	Color Control (ex. X+1)
#1	1	2
#2	3	4
#3	5	6

The fixture can be connected with RJ45 or XLR sockets. DMX cables **are not** included; please refer to compatible DMX cabling list for more information. The final fixture on each daisy chain should be terminated by the use of a DMX terminator purchased from a 3rd party or from Meteor.

CONNECTION	RJ45 (CAT5e)	5-PIN XLR
Common	WHITE/BROWN(PIN7) & BROWN (PIN 8)	PIN 1
Signal -	ORANGE (PIN 2)	PIN 2
Signal +	WHITE/ORANGE (PIN 1)	PIN 3
Spare	-	PIN 4
Spare	-	PIN 5

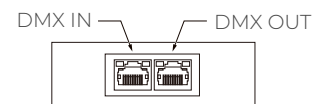

RJ45 Sockets



DMX IN DMX OUT

XLR Sockets

COMPATIBLE DMX CABLING LIST

DMX uses a cable consisting of two twisted pairs plus a shield to carry data. The cable must be specifically impedance matched for the digital DMX signal, meaning that microphone cable or other non-rated cable **must not be used to carry DMX**. Network cable (Cat5, 5e or 6 cable) may be used to carry DMX in an installation; however special consideration must be given to shielding and termination. Under no circumstances should solid core cable like Cat5 be terminated into a screw down connector.

Meteor recommends the use of Belden 9729 or Belden 9841 for DMX installation. Belden 9729/9841 is a two pair cable, which allows for a spare pair for 'out and back' type terminations if needed.

DIMENSIONS

